

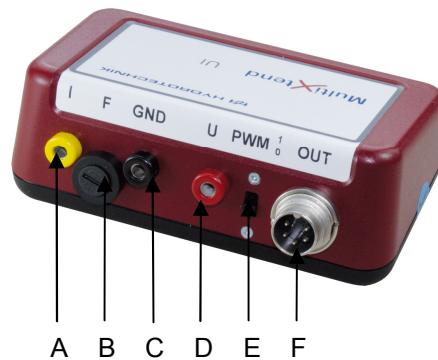
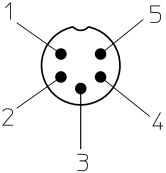

	<p><b>MultiXtend UI</b> 316A-A0-00.xx</p> <p>Strom- /Spannungsadapter zur Umsetzung von <math>\pm 30</math> VDC / <math>\pm 2</math> ADC oder <math>\pm 60</math> VDC / <math>\pm 4</math> ADC auf Normsignal</p>	<p><math>\pm 30</math> VDC / <math>\pm 2</math> ADC <math>\rightarrow</math> 0...20 mA <math>\pm 60</math> VDC / <math>\pm 4</math> ADC <math>\rightarrow</math> 0...20 mA</p> <p><i>current-/voltage adaptor to transform <math>\pm 30</math>VDC / <math>\pm 2</math>ADC or <math>\pm 60</math> VDC / <math>\pm 4</math> ADC to standardized signals</i></p>
<p><b>Beschreibung</b> <i>Description</i></p>	<p>Der MultiXtend UI ist ein Adapter zur Umwandlung von Strom und Spannung auf das Normsignal 0...20 mA. Es können damit positive und negative Spannungen / Ströme gemessen werden. Der Nullpunkt liegt bei 10 mA.</p>	<p><i>The MutliXtend UI is an adaptor to transform current and voltage to the standardized signal 0...20 mA. It is possible to measure positive and negative voltages / currents. The zero point is at the signal level of 10 mA.</i></p>
<p><b>Eigenschaften</b> <i>Qualities</i></p>	<ul style="list-style-type: none"> <li>• Ausgangssignal 0...20 mA</li> <li>• Hochohmiger oder niederohmiger Spannungseingang</li> <li>• Niederohmiger Stromeingang</li> <li>• Galvanische Trennung von Ein- und Ausgang</li> <li>• Zuschaltbarer Hardwarefilter für PWM-Signal</li> <li>• Temperaturbereich -20 ...+85°C</li> <li>• Kompatibel zu allen Hydrotechnik Messgeräten</li> </ul>	<ul style="list-style-type: none"> <li>• <i>output signal 0...20 mA</i></li> <li>• <i>high-impedance voltage or low-impedance input</i></li> <li>• <i>low-impedance current input</i></li> <li>• <i>input and output galvanically isolated</i></li> <li>• <i>switchable hardware filter for PWM-signals</i></li> <li>• <i>temperature range -4...+185°F</i></li> <li>• <i>compatible with all Hydrotechnik measuring instruments</i></li> </ul>
<p><b>Verwendungszweck</b> <i>Designated use</i></p>	<p>Messung höhere Spannungen und Ströme mit Messgeräten, die nur Standardsignaleingänge besitzen.</p>	<p><i>Measure higher voltages and currents with measuring instruments that have inputs for standardized signals only.</i></p>

**Elektrische Verbindungen**  
**Electrical connections**

- A: Stromeingang / *current input*  
 B: Sicherungshalter für Feinsicherung / *Fuse holder for microfuse*  
 C: Masse / *ground*  
 D: Spannungseingang / *voltage input*  
 E: Schalter für Hardwarefilter(PWM-Filter) / *switch to activate hardware filter(PWM filter)*  
 F: Anschluss zum Messgerät / *connection to measuring instrument*

Pinbelegungen <i>Pin assignments</i>	Bezeichnung <i>Labeling</i>	Nr. <i>No</i>	Funktion	Function
Rundsteckverbinder M16 x 0.75 mit Schraubverriegelung, Ausführung 05-a, 5-polig, Stecker <i>Circular connectors M16 x 0.75 with screw-locking Layout 05-a, 5 poles, male IEC / DIN EN 61076-2-106</i>				
Stecker / plug OUT  M16 5p m	Signal	1	Signal	<i>signal</i>
	GND Ub/Signal	2	Versorgungs- und Signalmasse	<i>supply and signal ground</i>
	+Ub	3	Versorgung +	<i>supply +</i>
	NC	4	nicht verbunden	<i>not connected</i>
	NC	5	nicht verbunden	<i>not connected</i>
BIL 20 Buchse mit Isolierkopf und -ring zum Einbau, für 4 mm Stecker gelb <i>Socket with insulated head and ring for installation, for 4 mm plug yellow</i>				
Buchse / jack 	I	1	Stromeingang	<i>current input</i>
BIL 20 Buchse mit Isolierkopf und -ring zum Einbau, für 4 mm Stecker rot <i>Socket with insulated head and ring for installation, for 4 mm plug red</i>				
Buchse / jack 	U	1	Spannungseingang	<i>voltage input</i>
BIL 20 Buchse mit Isolierkopf und -ring zum Einbau, für 4 mm Stecker schwarz <i>Socket with insulated head and ring for installation, for 4 mm plug black</i>				
Buchse / jack 	GND	1	Masse	<i>ground</i>

## Sicherungshalter für Feinsicherung / Fuse holder for microfuse

	F <sub>I</sub>	M2A für Ausgang von ±30 VDC / ±2 ADC M4A für Ausgang von ±60 VDC / ±4 ADC	M2A for output of ± 30 VDC / ± 2 ADC M4A for output of ± 60 VDC / ± 4 ADC
---	----------------	--	--

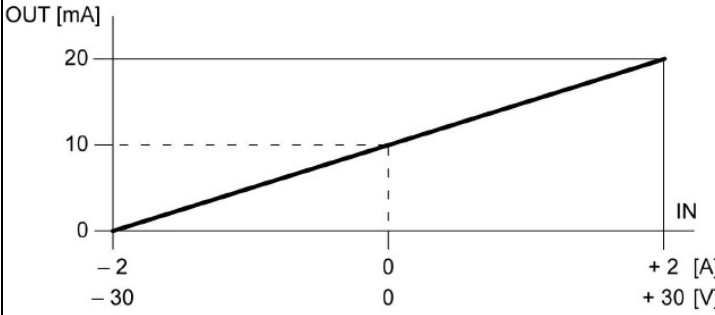
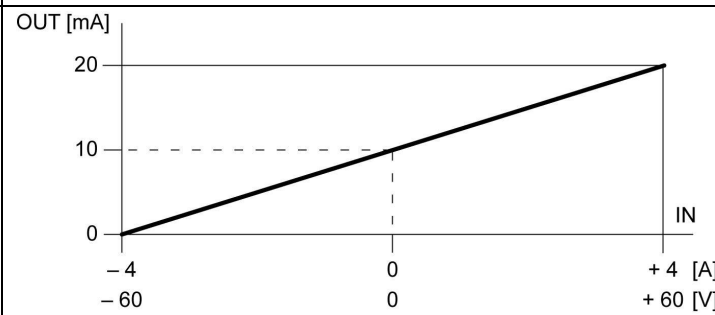
<b>Einstellung im Messgerät</b> <b>Setting in measuring instrument</b> ±30 VDC / ±2 ADC → 0...20 mA	
	A) Kalibrierwert / calibration value : I = 4A oder / or U = 60V Durchführung eines Nullpunktabgleichs ohne Signal notwendig / <i>zero point alignment without signal is necessary</i> B) Messbereich / measuring range : I = -2A ...+2A oder / or U = -30V ... +30V
<b>Einstellung im Messgerät</b> <b>setting in measuring instrument</b> ±60 VDC / ±4 ADC → 0...20mA	
	C) Kalibrierwert / calibration value : I = 8A oder / or U = 120V Durchführung eines Nullpunktabgleichs ohne Signal notwendig / <i>zero point alignment without signal is necessary</i> D) Messbereich / measuring range : I = -4A ...+4A oder / or U = -60V ... +60V

Absolute Grenzwerte Absolute maximum rating	Min	Typ.	Max	Einheit Unit	Symbol Icon	Bemerkung Remarks
Versorgungsspannung / Supply voltage	13		30	VDC	V+	Ta=25°C Ta=77°F
Betriebstemperatur / operating temperature	-20 (-4)		85 (185)	°C (°F)	To	
Lagertemperatur / storage temperature	-40 (-40)		125 (257)	°C (°F)	Ts	
Relative Feuchte / relative humidity	0		80	%	r.F.	Nicht betauend / not condensing

<b>Elektrische Eigenschaften</b> <i>Electrical qualities</i>		Referenzbedingungen / Reference conditions: Umgebungstemperatur Ta=25°C / environmental temperature Ta=77°F			
Parameter	Min	Typ.	Max	Einheit Units	Bemerkung Remarks
Versorgungsstrom / supply current		40		mA	ohne Signal / without signal
<b>±30 VDC / ±2 ADC → 0...20 mA</b> <b>Hochohmig / high impedance</b>					
Eingangssignal Strom / input signal current	-2		2	ADC	
Eingangssignal Spannung / input signal voltage	-30		30	VDC	
Fehlergrenzen Eingangssignal / error limits input signal			1	%FS	
Eingangswiderstand Strom / input impedance current		0.1		Ω	Toleranz ±5% tolerance ±5%
Eingangswiderstand Spannung / input impedance voltage		10'000		kΩ	Toleranz ±5% tolerance ±5%
<b>±60 VDC / ±4 ADC → 0...20 mA</b> <b>Niederohmig / low impedance</b>					
Eingangssignal Strom / input signal current	-4		4	ADC	
Eingangssignal Spannung / input signal voltage	-60		60	VDC	
Fehlergrenzen Eingangssignal / error limits input signal			1	%FS	
Eingangswiderstand Strom / input impedance current		0.05		Ω	Toleranz ±5% tolerance ±5%
Eingangswiderstand Spannung / input impedance voltage		60		kΩ	Toleranz ±5% tolerance ±5%
Temperaturfehler / temperature error	-0.03		+0.03	%/°C	
Einschwingzeit ohne PWM-Filter / response time without PWM-filter		5		ms	Signalsprung von 10 auf 90 % vom Endwert / signal change from 10 to 90 % of full scale
Einschwingzeit mit PWM-Filter / response time with PWM-filter		250		ms	Signalsprung von 10 auf 90 % vom Endwert / signal change from 10 to 90 % of full scale
Galvanische Trennung / galvanic isolation			70	VDC	

<b>Mechanische Eigenschaften</b> <i>Mechanical characteristics</i>	
Gehäuse / Casing	Kunststoff mit EMV Beschichtung / Plastic with EMC coat
Schutzart / IP protection class	IP 40
Gewicht / Weight	190g

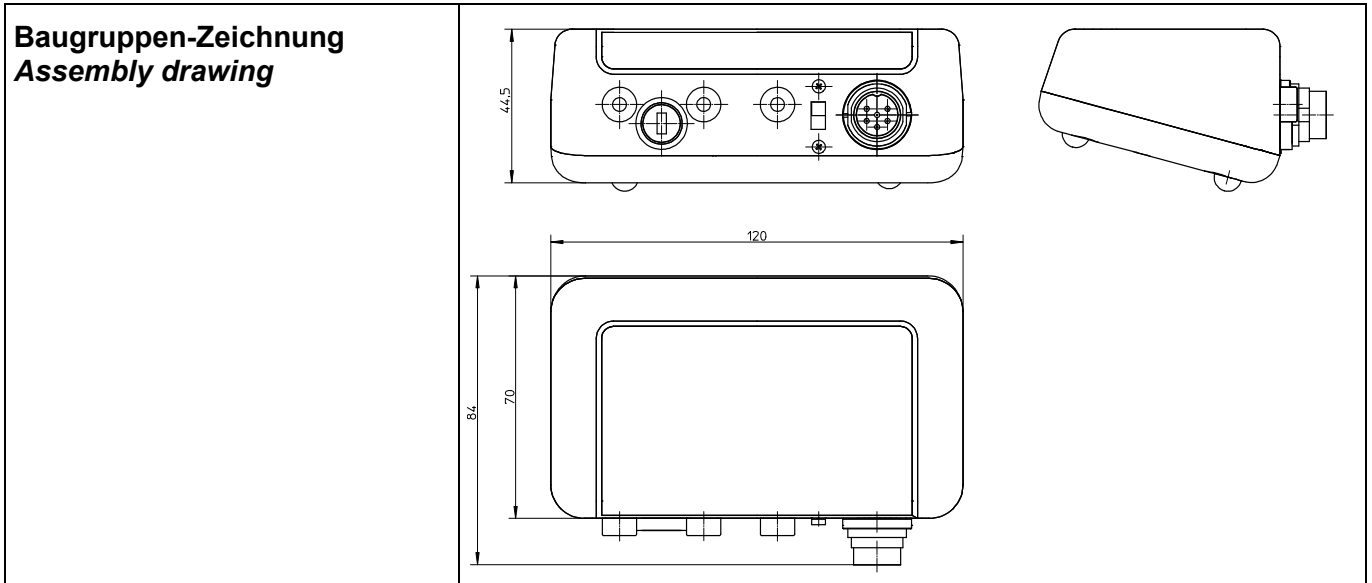
**Verpackung / Packing**

MultiXtend UI wird in einem Karton verpackt geliefert.  
*MultiXtend UI is delivered in a box.*

**Typenschild**  
**Type plate**

**MultiXtend UI** CE

Bestell-Nr. / Part-No. 316A-A0-00.20  
 Eingangssignal / Input  $\pm 2A/\pm 30V$   
 Ausgangssignal / Output 0 ... 20mA  
 Versorgungsspannung / Supply voltage 13 ... 30 VDC  
 Werk-Nr. / Serial-No 02187

**HYDROTECHNIK**  
 MESSEN MIT SYSTEM



**MultiXtend UI** CE

Bestell-Nr. / Part-No. 316A-A0-00.30  
 Eingangssignal / Input  $\pm 4A/\pm 60V$   
 Ausgangssignal / Output 0 ... 20mA  
 Versorgungsspannung / Supply voltage 13 ... 30 VDC  
 Werk-Nr. / Serial-No 00217

**HYDROTECHNIK**  
 MESSEN MIT SYSTEM



TKZ / order number	Eingangssignal / input signal	Bemerkung / remarks
316A-A0-00.20	$\pm 30$ VDC / $\pm 2$ ADC	Hochohmig / high impedance
316A-A0-00.30	$\pm 60$ VDC / $\pm 4$ ADC	Niederohmig / low impedance

<b>Europäische Konformität</b> <b>European Conformity</b>	<b>CE</b>	
Elektromagnetische Verträglichkeit / electromagnetic compatibility	Richtlinie 2004/108/EG	Directive 2004/108/EC

<b>Haftungsausschluss /</b> <b>Limitation of Liability</b>	<p>Hydrotechnik behält sich Änderungen an diesem Dokument vor, ohne vorherige Information. Im Zweifelsfall gilt die deutsche Sprachversion. Angaben in Klammern dienen nur zur Information.</p> <p><i>Hydrotechnik reserves the right to modify this document without prior notice. The German language version is valid in any case of doubt. Data in brackets only given for information.</i></p>
---	---

Revision	Rev 01	Rev 02	Rev 03	Rev 04	Rev 05	Rev 06	Rev 07	Rev 08
	26.05.2011	15.08.2012	2014-10-02					
	CF	AK	MM					