

# Pressure switches type MAP

with fixed switching pressure differential and microswitch with gold plated contacts

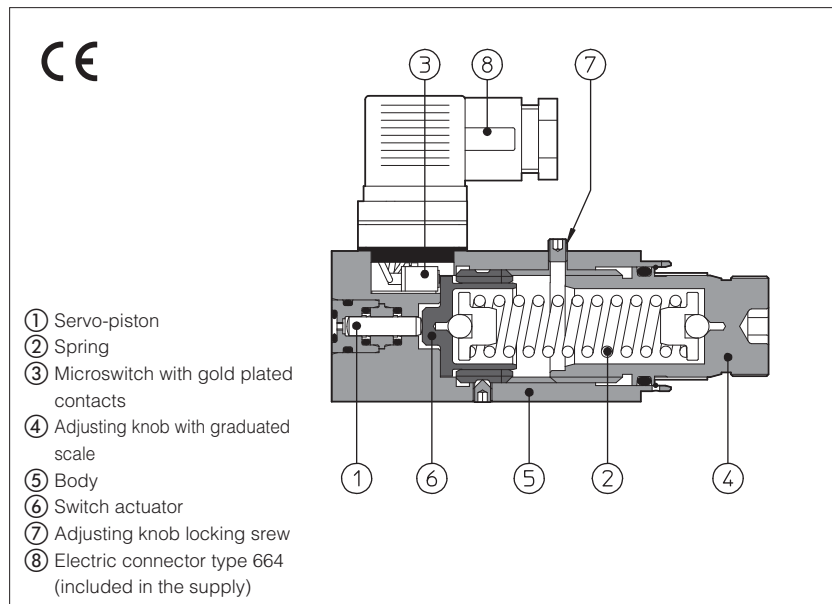

**MAP** are hydro-electric pressure switches with fixed switching pressure differential. The mechanical microswitch with gold plated contacts grants high reliability and long life service.

The microswitch changes its status when the pressure in the hydraulic circuit reaches the switching value set on the adjusting knob. The microswitch returns to the original rest position when the pressure in the hydraulic circuit drops below the nominal fixed switching pressure differential (hysteresis). The electric connector provides both NC or NO contacts.

The pressure in the circuit operates the piston (1) acting against the adjustable spring (2); once the pressure setting is reached, the piston (6) actuates the microswitch (3).

The pressure switching value is selectable by a graduated adjusting knob (4).

Clockwise rotation increases the setting pressure.

Max pressure: **630 bar**

## 1 MODEL CODE

<b>MAP</b>	-	<b>160</b>	/	<b>E</b>	/	<b>**</b>	/	<b>*</b>
Fixed differential pressure switch					Series number	Seals material, see section 2: - = NBR <b>PE</b> = FKM <b>BT</b> = HNBR		
Pressure range:	<b>160</b>	=	10 ÷ 160 bar					
	<b>40</b>	=	5 ÷ 40 bar					
	<b>320</b>	=	30 ÷ 320 bar					
	<b>80</b>	=	7 ÷ 80 bar					
	<b>630</b>	=	50 ÷ 630 bar					
				Options:				
				<b>E</b> = Common electric contact connected to pin 1, see section 3				

## 2 MAIN CHARACTERISTICS, SEALS AND HYDRAULIC FLUID - for other fluids not included in below table, consult our technical office

Assembly position / location	Any position		
Subplate surface finishing	Roughness index Ra 0,4 - flatness ratio 0,01/100 (ISO 1101)		
Compliance	CE to Low Voltage Directive 2014/35/EU RoHS Directive 2011/65/EU as last update by 2015/65/EU REACH Regulation (EC) n°1907/2006		
Ambient temperature	<b>Standard</b> = -30°C ÷ +70°C <b>/PE option</b> = -20°C ÷ +70°C <b>/BT option</b> = -40°C ÷ +70°C		
Seals, recommended fluid temperature	NBR seals (standard) = -20°C ÷ +60°C, with HFC hydraulic fluids = -20°C ÷ +50°C FKM seals (/PE option) = -20°C ÷ +80°C HNBR seals (/BT option) = -40°C ÷ +60°C, with HFC hydraulic fluids = -40°C ÷ +50°C		
Recommended viscosity	15 ÷ 100 mm <sup>2</sup> /s - max allowed range 2,8 ÷ 500 mm <sup>2</sup> /s		
Fluid contamination class	ISO 4406 class 21/19/16 NAS 1638 class 10, in line filters of 25 µm (β <sub>25</sub> ≥ 75 recommended)		
<b>Hydraulic fluid</b>	<b>Suitable seals type</b>	<b>Classification</b>	<b>Ref. Standard</b>
Mineral oils	NBR, FKM, HNBR	HL, HLP, HLPD, HVLP, HVLPD	DIN 51524
Flame resistant without water	FKM	HFUD, HFDR	ISO 12922
Flame resistant with water	NBR, HNBR	HFC	

## 3 CHARACTERISTICS AND WIRING OF INTERNAL MICROSWITCH

	Supply voltage [V]				STD	Rest position	Pressure operated position
	125 AC	250 AC	30 DC	250 DC			
Max current resistive load [A]	7	5	5	0,2	/E		
Max current inductive load (Cos φ = 0,4) [A]	4	2	3	0,02			
Insulating resistance	≥100MΩ				/E		
Contact resistance	15 mΩ						
Electrical life-expectancy	≥1.000.000 switchings						
Mechanical life-expectancy	≥10.000.000 switchings						

#### 4 DIAGRAMS

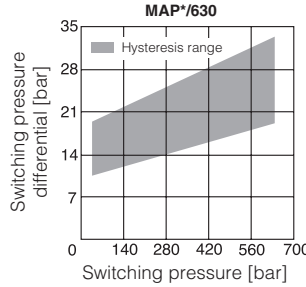
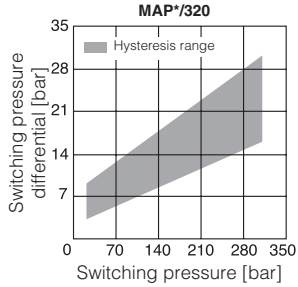
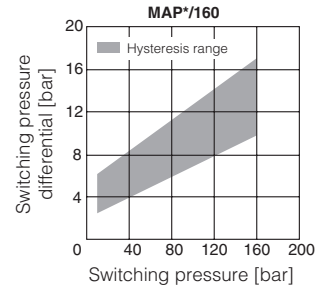
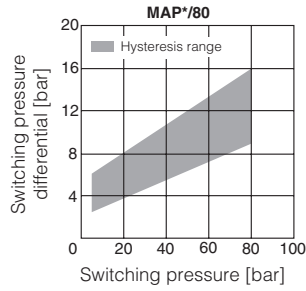
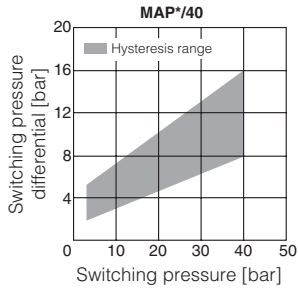

The diagrams show, the switching pressure difference (hysteresis) between the switching positions of the pressure switch electric contacts.

⚠ The switching pressure differential may increase depending to the deterioration of the fluid contamination class.

#### 5 DIMENSIONS OF MAP WITHOUT ADAPTORS [mm]

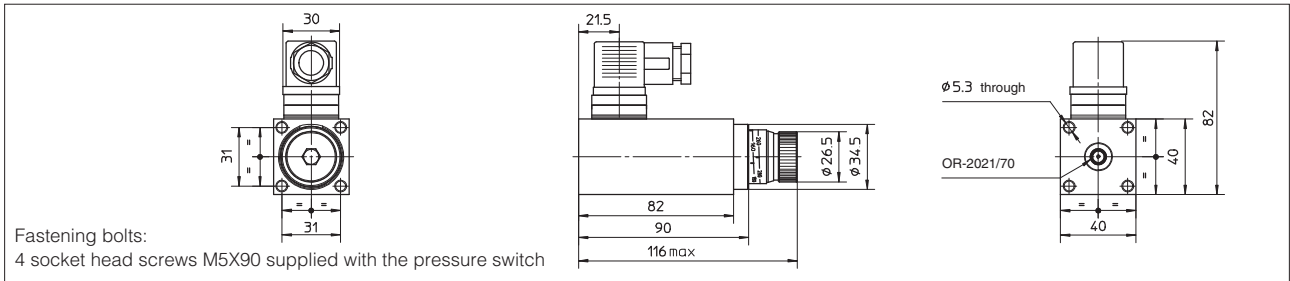

#### 6 MODEL CODE FOR ADAPTORS WHEN SUPPLIED SEPARATELY - BHM and BKM with option /PE or /BT are available on request

BHM	**
Type of adaptor	Threated connections for BMM and BFM adaptors, see section 7 BHM and BKM adaptors, see section 7
<b>BMM</b> = male	
<b>BMF</b> = female	
<b>BFM</b> = in-line	
<b>BHM</b> = ISO 4401 size 06	<b>06</b> = G 1/4" (BMM, BMF, BFM) <b>20</b> = G 3/4" (BFM)
<b>BKM</b> = ISO 4401 size 10	<b>10</b> = G 3/8" (BMM, BFM) <b>25</b> = G 1" (BFM)
	<b>15</b> = G 1/2" (BMM, BFM) <b>32</b> = G 1 1/4" (BFM)
	<b>11</b> = port P <b>14</b> = port B
	<b>12</b> = port A and B <b>17</b> = port P and A
	<b>13</b> = port A <b>18</b> = port P and B

#### 7 DIMENSIONS OF ADAPTORS [mm]

**BMM - Male fittings:**

Weight: 0,3 Kg

**BMF - Female fittings:**

	A	B	C	Ø D	E	F
<b>BMM-06</b>	22,5	11	1,5	18	G 1/4"	20
<b>BMM-10</b>	23,5	11,5	2	22	G 3/8"	20
<b>BMM-15</b>	27,5	15	2,5	26	G 1/2"	20

**BHM - Modular mounting surface ISO 4401-03-02-0-05**

Weight: 1,2 Kg

**BFM - In-line mounting:**

Weight: 0,8 Kg

	A	B	Ø D	E	F	G	H
<b>BFM-06</b>	50	20	19	G 1/4"	22,5	1	12
<b>BFM-10</b>	50	20	23	G 3/8"	22,5	1	12
<b>BFM-15</b>	50	20	27	G 1/2"	22,5	1	15
<b>BFM-20</b>	50	20	33	G 3/4"	22,5	1,5	17
<b>BFM-25</b>	70	30	40	G 1"	30	1,5	19
<b>BFM-32</b>	70	30	50	G 1 1/4"	30	1,5	22

**BKM - Modular mounting surface ISO 4401-05-03-0-05**

Weight: 2 Kg

For versions 11 and 13 the pressure switch is mounted on side of port A. For version 14 the pressure switch is mounted on side of port B. For versions 12, 17, 18 the pressure switch is mounted on both sides.