

Proportional amplifier type EV2S

Product documentation



Line connector

Supply voltage U_B : 10...30 V DC

Output current I_A : max. 2 A



© by HAWE Hydraulik SE.

The reproduction and distribution of this document as well as the use and communication of its contents to others without explicit authorisation is prohibited.

Offenders will be held liable for the payment of damages.

All rights reserved in the event of patent or utility model applications.

Brand names, product names and trademarks are not specifically indicated. In particular with regard to registered and protected names and trademarks, usage is subject to legal provisions.

HAWE Hydraulik respects these legal provisions in all cases.

Printing date / document generated on: 19.09.2017

1	Overview of proportional amplifier type EV2S.....	4
2	Available versions, main data.....	5
2.1	Accessories.....	6
3	Parameters.....	7
3.1	General data.....	7
3.2	Electrical parameters.....	8
3.3	Communication.....	9
3.4	Electro-magnetic compatibility (EMC).....	9
4	Dimensions.....	10
5	Installation, operation and maintenance information.....	11
5.1	Electrical connection.....	11
5.2	Operating instructions.....	12
5.3	Instructions for adjustment with buttons (type EV2S).....	15
5.4	Initial operation (quick start).....	22
5.5	Instructions for setting up with software.....	24
5.6	Error management.....	25
5.7	Changing the device type.....	26
6	Other information.....	27
6.1	Typical circuits.....	27
6.2	Initial commissioning kit.....	28

Overview of proportional amplifier type EV2S

Proportional amplifiers actuate proportional solenoid valves by converting an input signal into a corresponding control current.

The proportional amplifier type EV2S has been developed for direct mounting onto a solenoid valve as a line connector.

It is suitable for controlling proportional single-action and twin solenoids. The feedback measurement at the valve outputs identifies and corrects the effects of temperature and the power supply. This ensures that the valve behaves in a reproducible, precise manner.

Important parameters (e.g. input signal, minimum current, maximum current, dither, ramp times etc.) can either be set using the pushbutton and an integrated display or via CAN bus using software on the computer or via Bluetooth using the smartphone app.

Features and benefits:

- Direct assembly onto the solenoid valves
- Easy commissioning
- Up to two analogue inputs for target value signals
- Control of twin and single valves
- CAN bus interface
- Bluetooth interface (optional)
- Simple diagnostics and status monitoring
- Functions and settings tailored to HAWE products

Intended applications:

- For controlling proportional valves in mobile machines and in the industry sector
- Connection of analogue proportional valves in CAN bus networks
- Closed control circuits
- Simple expansion of existing systems



Proportional amplifier type EV2S

2 Available versions, main data

Order coding example:

EV2S	- CAN	- G	- L3K
		Electrical connection	Table 3 Electrical connection
		Version	Table 2 Version
	Data interface		Table 1 Data interface

Basic type

Table 1 Data interface

Marking	Description
CAN	CAN interface
BT	Bluetooth interface, CAN interface

Table 2 Version

Marking	Description
G	Line connector for single-action and twin solenoids with socket according to DIN EN 175 301-803
DG	2 x line connector for two single-action solenoids with socket according to DIN EN 175 301-803. Not for BT data interface (table 1)

Table 3 Electrical connection

Marking	Description
L3K	3 m cable with open line ends 5 x 0.5 mm ² . Not for BT data interfaces (table 1)
M	M12 plug, 5-pole, only for version G (table 2)

2.1 Accessories

PEAK-System CAN USB dongle

Order coding:	PCAN-USB ADAPTER
Order number:	6219 2001-00
Description:	USB CAN adapter from PEAK-System. For connecting a proportional amplifier type EV2S and a PC.

Line connector adapter from DIN A to DIN B

Order coding:	ADAPTER FORM A – FORM B
Order number:	6217 0238-00
Description:	Adapter for controlling solenoids with a DIN connection using an EV2S.

Initial commissioning kit

Order coding:	EV2S-DEVELOPMENT-KIT
Order number:	6964 0009-08
Description:	For commissioning <ul style="list-style-type: none">▪ Consists of a 24 VDC power supply unit▪ 9-pole D-Sub plug including termination for CAN bus connection to a PC (PEAK USB ADAPTER required)▪ M12 plug▪ Terminals for connecting the EV2S

Smartphone app

Order coding:	Hawe eControl
Description:	Simple connection: The electric amplifier EV2S-BT can connect with an Apple iPhone or Android smartphone via Bluetooth. The HAWE eControl app is available for free from the Apple App Store or Google Play Store. Function <ul style="list-style-type: none">▪ Commissioning▪ Live data for diagnostics and monitoring▪ Change, save and duplicate settings▪ Send or receive saved settings

3 Parameters

3.1 General data

Nomenclature	Proportional amplifier
Design	line connector
Connection leads	<ul style="list-style-type: none"> • 3 m cable 5 x 0.5 mm² • M12, 5 pin
Installation position	On socket according to DIN EN 175 301-803
Installation position	As desired
Weight	<ul style="list-style-type: none"> ▪ approx. 70 g
Protection class	IP65 (mounted) according to DIN VDE 0470 , DIN EN 60529 or IEC 529
Ambient temperature	CAN: -40 to +80°C BT: -40 to +70°C

3.2 Electrical parameters

Supply voltage	U_B	10 to 30 V DC, pole-protected
Output voltage	U_A	$U_B - 0.5$ V, pulse-width modulated
Unregulated output current	I_A	Short-circuit-proof, temperature-dependent - CAN: 0 to 2 A - BT: 0 to 1.6 A
Regulated output current	I_A	0 to 1.6 A, short-circuit proof, temperature-dependent (see Diagram 1)
Adjustment areas	I_{min} I_{max}	0 to 1 A - CAN: 0 to 2 A - BT: 0 to 1.6 A
Idle current	I_L	- CAN: < 35 mA - BT: < 60 mA
Possible input signal 1		<ul style="list-style-type: none"> • 0 to 5 V DC, $R_E = 36$ kΩ • 0 to 10 V DC, $R_E = 36$ kΩ • 4 to 20 mA, $R_E = 220$ Ω • $0.25 U_B \dots 0.75 U_B$, $R_E = 24$ kΩ • PWM, $R_E = 36$ kΩ
Possible input signal 2		<ul style="list-style-type: none"> • 0 to 5 V DC, $R_E = 24$ kΩ • 0 to 10 V DC, $R_E = 24$ kΩ • CAN bus • ± 10 V DC, $R_E = 24$ kΩ
Recommended target value potentiometer	R	≤ 10 k Ω
Ramp time	t_R	0 to 300 s Increase and decrease time can be adjusted separately
Dither frequency	f	50 to 250 Hz
Dither amplitude	l	0 to 100%
PWM frequency	f	50 to 1,000 Hz (temperature-dependent)

Temperature-dependent power during continuous operation

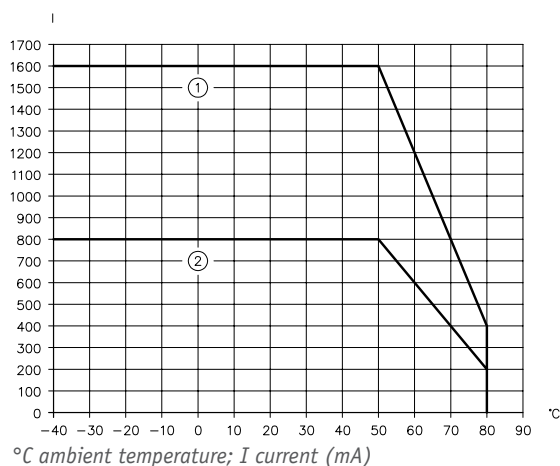

- 1 12 V systems
- 2 24V systems

3.3 Communication

CAN bus

CAN protocol	CANopen, J1939
CAN bit rate	10, 20, 50, 100, 125, 250, 400, 500, 800, 1,000 (all units in kbit/s)
CAN ID	1 to 127 (Default D = 126)

Bluetooth

Bluetooth protocol	Bluetooth 4.0 Low Energy
--------------------	--------------------------

3.4 Electro-magnetic compatibility (EMC)

The EMC of the device was tested using an accredited testing laboratory (emitted interference according to DIN EN 61000-6-3 and immunity to interference according to DIN EN 61000-6-2 evaluation criterion "B"). The test set-ups only represent typical use. This EMC testing does not release the user from carrying out adequate prescribed EMC testing of their complete system (according to Directive). If the EMC of the complete system must be further amplified, the following measures can be tested and introduced:

- Supply lines, such as inputs and outputs to and from the device, should be as short as possible. If necessary they should be shielded and twisted in pairs (to reduce the antennae-like effect for increasing the immunity to interference).

The EMC of the device in variant BT was tested using an accredited testing laboratory in accordance with EN 301 489-17.

4 Dimensions

All dimensions in mm, subject to change!

EV2S-CAN-G-L3K

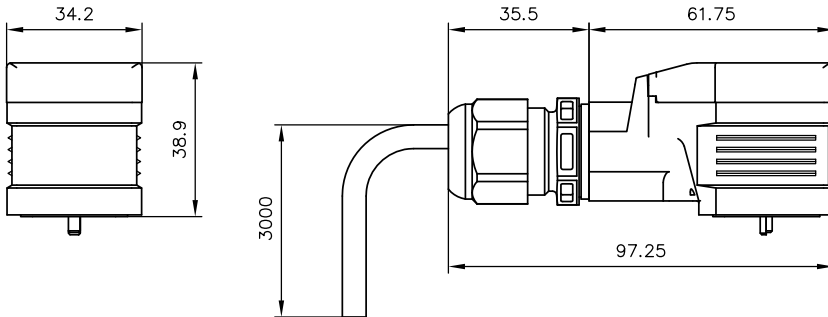

EV2S-CAN-G-M, EV2S-BT-G-M

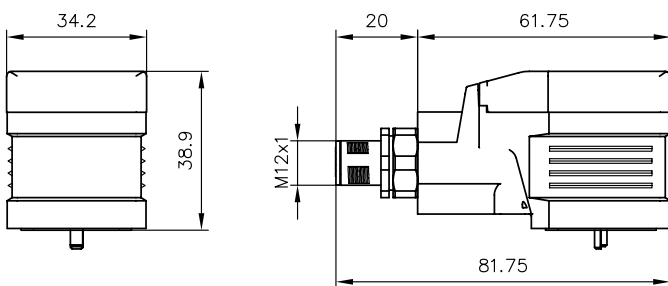

EV2S-CAN-DG-L3K

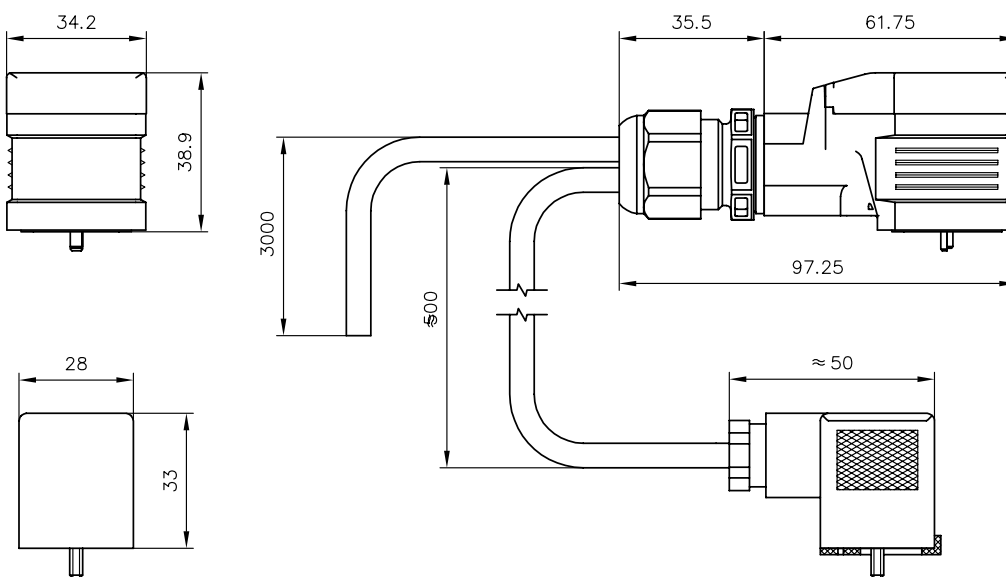

5 Installation, operation and maintenance information

5.1 Electrical connection

Connection pattern (magnet-side)

Connection	3-pole
Protection class	IP 65 according to DIN EN 60529

EV 2 S - CAN - G - ...

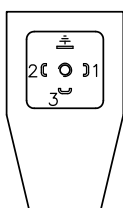

Twin solenoid

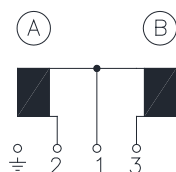

Single-action solenoid



EV 2 S - CAN - DG - L3K

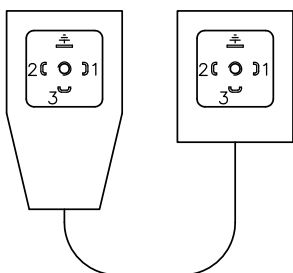

2 single-action solenoids

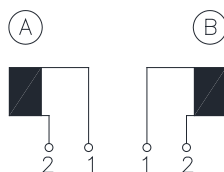

Layout plan

Signal	L3K	M	.. - M
	Litz wire number	M 12 pin	
U_B	1	1	
PGND / analogue input 1 GND	2	2	
Analogue input 1	3	3	
CAN-H / analogue input 2	4	4	
CAN-L / analogue input 2 GND	5	5	

5.2 Operating instructions

EV2S-CAN board

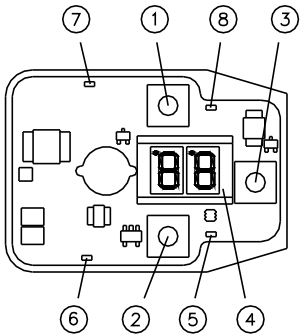

Layout plan

1	Button - UP
2	Button - DOWN
3	Button - OK / Back
4	Display
5	LED - Power (green)
6	LED - A-side (green)
7	LED - B-side (orange)
8	LED - Error (red)

EV2S-BT board

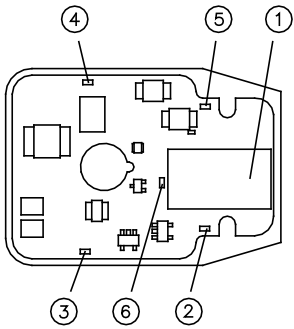

Layout plan

1	Bluetooth module
2	LED - Power (green)
3	LED - A-side (green)
4	LED - B-side (orange)
5	LED - Error (red)
6	LED - Bluetooth active (blue)

CAN communication

In a CAN network with 11-bit identifier protocol, the proportional amplifier type EV2S can be connected according to CAN 2.0A; with 29-bit identifier protocol, it can be connected according to CAN 2.0B.

Target values sent by a master can be converted into a valve current. An analogue sensor can also be read and the values sent to the master via CAN bus.

The proportional amplifier type EV2S is delivered with the ID 126.

The baud rate can be freely selected between 10 and 1,000 kbit/s. The default value is 250 kbit/s.

Input

Input signals can be directly converted into control current at the output. As there are many different input signals and customer requirements, it is necessary to provide a description of the input signal and the subsequent action.

The way the proportional amplifier should behave with the relevant input signal is defined in the user parameters, using the device type.

Analogue input 1 measures the generated signal on a differential basis. Analogue input 2 is referenced to ground. If the input signal permits it, analogue input 1 must be used in order to create more immunity against interference.

If analogue input 2 is being used, connect it to analogue input 1 GND.

Circuit examples (see [Chapter 6, "Other information"](#))

Example: 0.5 to 4.5 V DC joystick // twin valve

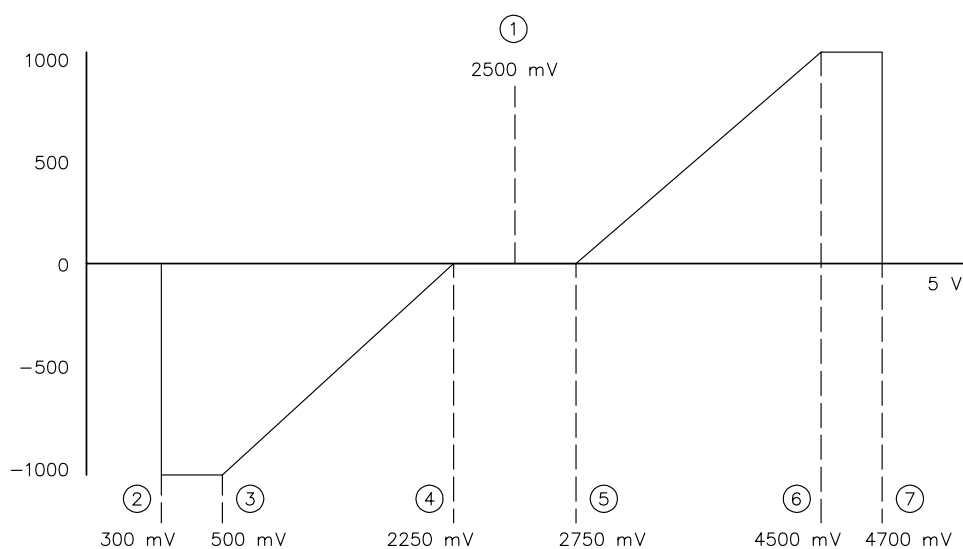

- 1 Middle value
- 2 Error bottom
- 3 Maximum negative
- 4 Minimum negative
- 5 Minimum positive
- 6 Maximum positive
- 7 Error top

Display (type EV2S-CAN)



The two-digit seven-character display shows the abbreviation for the selected menu item or the value of the selected user parameter within the menu structure. Values ranging from -9,999 to +99,999 may be shown. User parameters with values ranging from 0 to 99 are shown directly in the character display. Values greater than 99 are shown individually in thousands, hundreds, tens and unit blocks. The display is similar to a combination lock.

Each block of values is displayed starting from the thousands by pressing **OK**. Pressing the **OK** button again in the single unit range switches to the thousands range.





The current block of values is shown with two items in the display. At the top of the character display, the items light up differently depending on the block of values.

The **negative numbers** are displayed as follows:





The symbol is only entered and displayed in the thousands position. To do this, the thousands position must be decreased to the zero value by pressing the **DOWN** button. The symbol is then changed by pressing and holding the **DOWN** button, if the value range permits this. By pressing the **UP** or **DOWN** button, the digits can be increased or decreased as usual.

The **standby** function is displayed after successful initial commissioning. An item then flashes slowly and continuously in the right display field. An **error code** is displayed in the event of an error. This enables troubleshooting to be carried out more quickly.

Example 12,438 explains the display of positive values.

Values	Coding	Example	
1,000 to 99,000	Left and right item	12,000	
100 to 900	Left item	400	
10 to 90	Right item	30	
1 to 9	No item	8	

Example -5,678 explains the display of negative values.

Values	Coding	Example	
-1,000 to -9,000	Left and right item	-5,000	
100 to 900	Left item	600	
10 to 90	Right item	70	
1 to 9	No item	8	

LED displays

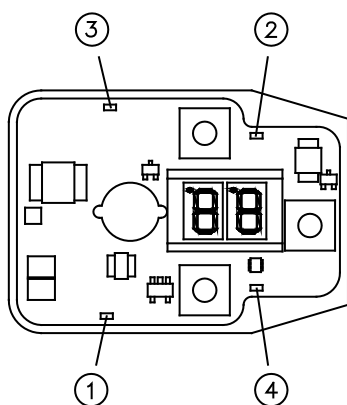

Four LEDs are built into the board to enable simple status monitoring. If the LEDs light up one after another, this means the device firmware is damaged and needs to be reinstalled.

Position	Colour	Description
1	Green	Solenoid output A, active: Lights up when the output for the A side is active
2	Red	Error: Light for when an error is detected
3	Orange	Solenoid output B, active: Lights up when the output for the B side is active
4	Green	Power: Lights up continuously when the device is correctly supplied with voltage

5.3 Instructions for adjustment with buttons (type EV2S)

The proportional amplifier is parametrised using three buttons and a two-digit seven-segment display. Key values can be selected, requested and modified via the menu items using the three buttons. The designation of the selected parameter and the current values are shown in the display.



Note

In order to open the proportional amplifier cover without risk of damage, the M3 tapped plug must first be fully removed. Pay attention to the correct position of the O-ring during assembly.

Navigation

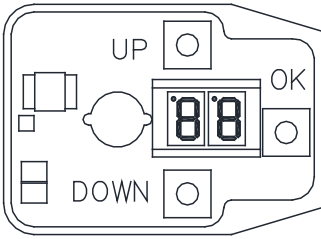

The individual menu items are selected using the **UP** and **DOWN** buttons in the menu.

OK confirms the selection and takes you to the relevant submenu and/or user parameters.

In order to return to the main menu, the **OK** button must be pressed until the new menu item is displayed.

The user parameter values are also modified using the UP and DOWN buttons. The value is increased/decreased by pressing the button once. Pressing and holding the button down automatically increases/decreases the value until the button is released. Modifications to the user parameter are immediately saved.

If there is no input after more than 120 seconds, the menu is exited.

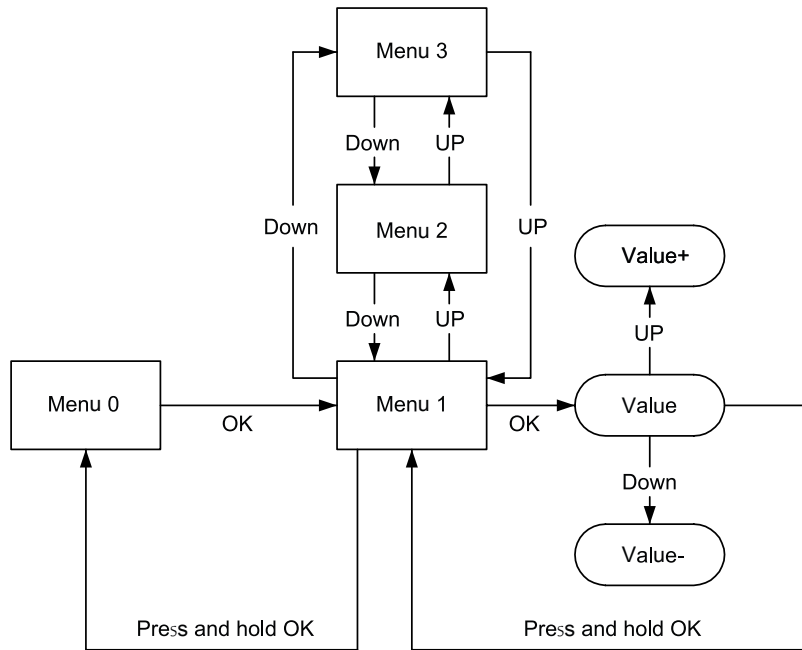

Menu

Press any button to access **data** in the parameter menu. Press the **OK** button to navigate further into the menu structure (change from main menu to submenu 1).

Table: Main menu and submenu 1

Main menu	Display	Submenu 1	Display
Configuration	C	Password	CP
		Reset	Cr
		CAN	Cc
		Device type	Cd
Input	A	Input 2	A2
		Input 1	A1
Output	P	Output 2	P2
		Output 1	P1
Data	d	Diagnostics	dI
		Product information	In
		Time	rt
		Supply voltage	Ub
		Temperature	tE

Table: User parameter data

Submenu 1	User parameters	Display	Minimum value	Maximum value	Description
Diagnostics (dI)	Current target value	A5	Actual value display		Actual, calculated target value
	Current measured value 2	A2	Actual value display		Actual analogue value 2 in V/mA/%
	Current measured value 1	A1	Actual value display		Actual analogue value 1 in V/mA/%
	Part number	t _n	Actual value display		HAWE part number
Product information (In)	Serial number	S _n	Actual value display		Serial number
	Software version	S0	Actual value display		Version number Software
	Hardware version	hA	Actual value display		Serial number Hardware
Time (rt)	Total runtime	r _h	Actual value display		Runtime since initial commissioning in h
	Runtime	r _r	Actual value display		Runtime since last reset in h/min/sec
	Supply voltage	U _b	Actual value display		Supply voltage in mV
	Temperature	t _E	Actual value display		Temperature in °C

Table: User parameters output 1

User parameters	Display	Minimum value	Maximum value	Description
Resistance 1	r0	1	40	In Ω
Dither amplitude 1	dA	0	98	In %
Dither frequency 1	dF	0	16	According to dither frequency table
Dither type 1	dt	0-1		Superimposed with 1 kHz, PWM
Ramp, down 1	rd	0	30,000	1/100 sec
Ramp, up 1	ru	0	30,000	1/100 sec
Maximum current 1	Ih	0	2,000	Maximum current at target value 100%
Minimum current 1	Il	0	1,000	Minimum current at target value 0.1%
Actual current 1	Ac	Actual value display		Actual current at the valve in mA

Table: User parameters output 2

User parameters	Display	Minimum value	Maximum value	Description
Resistance 2	r0	1	40	In Ω
Dither amplitude 2	dA	0	98	In %
Dither frequency 2	dF	0	16	According to dither frequency table
Dither type 2	dt	0-1		Superimposed with 1 kHz, PWM
Ramp, down 2	rd	0	30,000	1/100 sec
Ramp, up 2	ru	0	30,000	1/100 sec
Maximum current 2	Ih	0	2,000	Maximum current at target value 100%
Minimum current 2	Il	0	1,000	Minimum current at target value 0.1%
Actual current 2	Ac	Actual value display		Actual current at the valve in mA

Table: Dither frequency

Display	Frequency in Hz	Display	Frequency in Hz	Display	Frequency in Hz
0	50	6	71	12	125
1	52	7	76	13	142
2	55	8	83	14	166
3	58	9	90	15	200
4	62	10	100	16	250
5	66	11	111		

Table: User parameters input 1

User parameters	Display	Minimum value	Maximum value	Description
Calculated positive 1	CP	-1,000	1,000	Scaling, target value B side, per mil
Calculated negative 1	Cn	-1,000	1,000	Scaling, target value A side, per mil
Error above 1	Et			Upper error threshold
Maximum positive 1	AP			Target value for maximum deviation in the positive direction
Minimum positive 1	IP			Target value for initial deviation in the positive direction
Minimum negative 1	In			Target value for initial deviation in the negative direction
Maximum negative 1	An			Target value for maximum deviation in the negative direction
Error below 1	Eb			Lower error threshold
Ramp negative, down 1	nd	0	30,000	In 1/100 sec
Ramp negative, up 1	nU	0	30,000	In 1/100 sec
Ramp positive, down 1	Pd	0	30,000	In 1/100 sec
Ramp positive, up 1	PU	0	30,000	In 1/100 sec
Calculated value 1	CA	Actual value display -1,000	+1,000	Per mil
Raw value 1	rA	Actual value display		

Table: User parameters input 2

User parameters	Display	Minimum value	Maximum value	Description
Calculated positive 2	CP	-1,000	1,000	Scaling, target value B side, per mil
Calculated negative 2	Cn	-1,000	1,000	Scaling, target value A side, per mil
Error above 2	Et			Upper error threshold
Maximum positive 2	AP			Target value for maximum deviation in the positive direction
Minimum positive 2	IP			Target value for initial deviation in the positive direction
Minimum negative 2	In			Target value for initial deviation in the negative direction
Maximum negative 2	An			Target value for maximum deviation in the negative direction
Error below 2	Eb			Lower error threshold
Ramp negative, down 2	nd	0	30,000	In 1/100 sec
Ramp negative, up 2	nU	0	30,000	In 1/100 sec
Ramp positive, down 2	Pd	0	30,000	In 1/100 sec
Ramp positive, up 2	PU	0	30,000	In 1/100 sec
Calculated value 2	CA	Actual value display -1,000	+1,000	Per mil
Raw value 2	rA	Actual value display		

Table: Configuration / CAN configuration

Submenu 1	User parameters	Display	Minimum value	Maximum value	Description
	Password	CP	0	30,000	Password for locking the menu
	Reset	Cr			Press the UP and DOWN buttons simultaneously to restore the delivery condition
CAN (Cc)	CAN ID	CI	1	127	CAN ID (Default 126)
	CAN baud rate	Cb	10	1,000	CAN baud rate
	Device type	Cd	0	15	Device type according to table

5.4 Initial operation (quick start)

Switch on device

1. Connect power supply (litz wire/pin 1 and litz wire/pin 2)
2. Switch on power supply
- ✓ Display on **[-**

Select number of solenoids

- Single-action, twin and two single-action solenoids can be selected.
3. Select number of solenoids.

Display	Description
[-	No selection, invalid input
[1	One single-action solenoid
[2	One twin solenoid or two single-action solenoids (only possible with EV2S-CAN-DG-L3K)

Select operating mode using the **UP** and **DOWN** buttons. Confirm the selected operating mode with **OK**

- ✓ Display on **[-**

Select input signal

- To ensure operation without problems, it is essential to define the input signal correctly
4. Select input signal

Display	Input signal	Connection
[-	No selection, invalid input	
[0	0 to 10 V DC	Analogue input 1
[1	4 to 20 mA	Analogue input 1
[2	0 to 10 V DC	Analogue input 2
[3	CAN	Analogue input 2
[4	PWM	Analogue input 1
[5	2 x 0 to 10 V DC	Analogue input 1 & 2
[6	-10 to +10 V DC	Analogue input 2
[7	0.25 Ubat to 0.75 Ubat A: 0.49 Ubat to 0.25 Ubat, B: 0.51 Ubat to 0.75 Ubat	Analogue input 1
[8	0 to 5 V DC	Analogue input 1
[9	0 to 5 V DC	Analogue input 2

Select operating mode using the **UP** and **DOWN** buttons.
Confirm the selected operating mode with **OK**

- ✓ Display on **[U-**

Select supply voltage

5. Select supply voltage

Display	Description
U-	No selection, invalid input
12	12 V DC supply voltage
24	24 V DC supply voltage

Select operating mode using the **UP** and **DOWN** buttons.

Confirm the selected operating mode with **OK**

✓ Display on **P-**

Select valve type

Valve-specific settings, such as minimum current, maximum current, dither amplitude and dither frequency are crucial for ensuring that operation is as accurate as possible. Basic settings have been pre-defined for the most common valves

6. Select valve type

Display	Valve type	Minimum current	Maximum current	Dither amplitude	Dither frequency
P-	No selection, invalid input				
P0	General	0.0 A (12 V DC) 0.0 A (24 V DC)	1.0 A (12 V DC) 0.5 A (24 V DC)	50%	100 Hz, PWM
P1	PSL 2	0.34 A (12 V DC) 0.17 A (24 V DC)	1.16 A (12 V DC) 0.58 A (24 V DC)	50%	100 Hz, PWM
P2	PSL 3 & 5	0.37 A (12 V DC) 0.18 A (24 V DC)	1.26 A (12 V DC) 0.63 A (24 V DC)	50%	100 Hz, PWM
P3	EDL	0.46 A (12 V DC) 0.23 A (24 V DC)	1.56 A (12 V DC) 0.78 A (24 V DC)	50%	100 Hz, PWM
P4	EMP to V	0.4 A (12 V DC) 0.2 A (24 V DC)	1.6 A (12 V DC) 0.8 A (24 V DC)	50%	100 Hz, PWM
P5	PMV	0.2 A (12 V DC) 0.1 A (24 V DC)	1.26 A (12 V DC) 0.63 A (24 V DC)	30%	100 Hz, PWM
P6	PDV	0.2 A (12 V DC) 0.1 A (24 V DC)	1.2 A (12 V DC) 0.68 A (24 V DC)	30%	100 Hz, PWM
P7	PDM	0.2 A (12 V DC) 0.1 A (24 V DC)	1.26 A (12 V DC) 0.63 A (24 V DC)	30%	100 Hz, PWM
P8	SEH	0.18 A (12 V DC) 0.1 A (24 V DC)	1.26 A (12 V DC) 0.63 A (24 V DC)	30%	100 Hz, PWM

Select operating mode using the **UP** and **DOWN** buttons.

Confirm the selected operating mode with **OK**

✓ The display shows the setting for the first selection point "operating mode"

7. You can press **OK** to check the selected settings again

8. Save the settings by pressing the **UP** and **DOWN** buttons simultaneously for 2 seconds

✓ Ready for the next step: set the input signal and test the function

5.5 Instructions for setting up with software

- The proportional amplifier type EV2S can be parametrised using the HAWE Visual Tool parameterisation software via the CAN interface. A PEAK-System CAN USB dongle is required for this.
[PEAK USB-CAN driver for PEAK PCAN-USB CAN-interface](#)
- The document "EV2S User Manual" describes the software and the setting options in detail.
[Manual - Proportional amplifier type EV2S-CAN](#)
- EV2S - EDS file
[EV2S - EDS](#)



Note

Some file types open directly in the browser window by default. To download them, please right-click on the file names or file extension and then select "Save target as" or "Save link as".

5.6 Error management

The error code display consists of two displays. Firstly, the text "Er" is displayed, then the display changes to the error number.

Code	Designation	Group	Comment
Er 10	Error Bottom	Input 1	Cable break detection triggered
Er 11	Error Top	Input 1	Short-circuit detection triggered
Er 12	Error Middle	Input 1	For twin valves: Before a target value is set, a "zero target value" (joystick middle position) must first exist.
Er 13	Overload current signal	Input 1	Current signal above 20 mA measured
Er 20	Error Bottom	Input 2	Cable break detection triggered
Er 21	Error Top	Input 2	Short-circuit detection triggered
Er 22	Error Middle	Input 2	For twin valves: Before a target value is set, a "zero target value" (joystick middle position) must first exist.
Er 30	Error Open	Output 1	Cable break detected
Er 31	Error Short	Output 1	Short-circuit detected; error can only be removed by means of a reset or with a target value = 0%
Er 32	Error Range	Output 1	Target value cannot be reached. Connected valve coil resistance is too high, e.g. a 24 V valve coil is being used in the 12 V system.
Er 40	Error Open	Output 2	Cable break detected at output 2
Er 41	Error Short	Output 2	Short-circuit detected; error can only be removed by means of a reset or with a target value = 0%
Er 42	Error Range	Output 2	Target value cannot be reached. Connected valve coil resistance is too high, e.g. a 24 V valve coil is being used in the 12 V system.
Er 55	Heartbeat missing	CAN bus	No cyclical CAN open heartbeat telegram received
Er 56	Setpoint missing	CAN bus	No cyclic target value received (cycle time <= 300 ms)
Er 57	Startup missing	CAN bus	Startup telegram has not been received
Er 58	Bus Warning	CAN bus	E.g. CAN bus lines not correctly connected
Er 59	Bus OFF	CAN bus	E.g. incorrect baud rate selected/terminating resistor not present
Er 60	Temperature Warning	Temperature	Internal temperature too high; target values reduced automatically
Er 61	Temperature Shutdown	Temperature	Internal temperature is above maximum limit: outputs are deactivated
Er 70	No valid type	Parameter	The selected device type is invalid.
Er 80	Supply voltage low	Other	Supply voltage too low < 8 V DC
Er 81	Supply voltage high	Other	Supply voltage too high > 32 V DC
Er 82	AI1 / AI2 high	Other	2 x 0 to 10 V DC mode: target value > 0% at analogue input 1 and 2 simultaneously

5.7 Changing the device type

A device type is defined during initialisation of the proportional amplifier. The device type defines the response of the power outputs to input signals. The device type can be changed at a later point as described below:

1. Call up reset function using the menu items Configuration \square - Reset \square .
- ✓ Display shows $\square\square$.
2. Press and hold the UP and DOWN buttons simultaneously.
- ✓ Reset confirmation: Display shows $--$.
3. Remove power supply for at least 5 seconds.
4. Reconnect power supply.

Changing the device type via the menu

The device type can be changed using the menu items Configuration \square - Device type \square .

- The input signal configurations are reset to the delivery condition. <-- IMPORTANT!!
- Any input parameters that have been changed will be overwritten. <-- IMPORTANT!!
- Do not change the parameters for the power outputs or communication.
- The device type is defined using the table of device types.

Table: Device types

Device type	Input signal	Input	Solenoid type
1	0 to 10 V	Analogue input 1	Single solenoid
2	4 to 20 mA	Analogue input 1	Single solenoid
3	0 to 10 V	Analogue input 2	Single solenoid
4	2 x 0 to 10 V	Analogue input 1 and 2	Twin solenoid
5	± 10 V	Analogue input 2	Twin solenoid
6	Ratiometric to U_B	Analogue input 1	Twin solenoid
7	4 to 20 mA	Analogue input 1	Twin solenoid
8	0 to 10 V	Analogue input 1	Twin solenoid
9	0 to 5 V	Analogue input 1	Twin solenoid
10	CAN	CAN L/CAN H	Single/twin solenoid
11	0 to 10 V	Analogue input 2	Twin solenoid
12	0 to 5 V	Analogue input 2	Twin solenoid
13	PWM	Analogue input 1	Single solenoid
14	PWM	Analogue input 1	Twin solenoid
15	0 to 5 V	Analogue input 1	Single solenoid
16	0 to 5 V	Analogue input 2	Single solenoid
17	Ratiometric to U_B	Analogue input 1	Single solenoid
18	± 10 V	Analogue input 2	Single solenoid
19	2 x 0 to 10 V	Analogue input 1 and 2	Single solenoid

Changing the device type with the HAWE Visual Tool

- The device type is stored in parameter 18.
- The device types are described in the table of device types.

6 Other information

6.1 Typical circuits

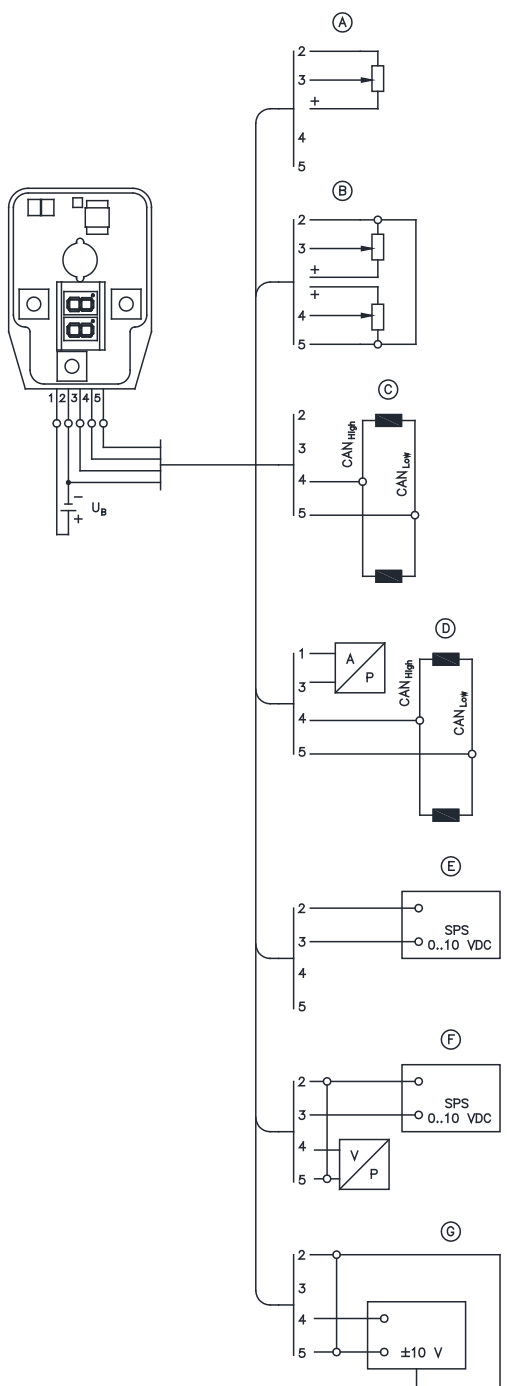

Example A Operation with an external target value potentiometer at analogue input 1, using the external power supply for the target value potentiometer

Example B Operation with two external target value potentiometers at analogue input 1 and 2, using the external power supply for the target value potentiometer

Example C Operation in the CAN bus network

Example D Operation in the CAN bus network and reading of a sensor (4 to 20 mA)

Example E Operation with an external target value source from PLC, CNC or computer

Example F Operation with external target value source from PLC, CNC or computer and control using analogue sensor (closed-loop control circuit)

Example G Operation with an external target value source from PLC, CNC or computer at analogue II

6.2 Initial commissioning kit

General parameters

Designation	Initial commissioning kit
Connection	<ul style="list-style-type: none"> ▪ Europlug type C ▪ M12, 5-pole ▪ Single-wire terminals, max. 2.5 mm² ▪ D-Sub plug DE-9
Weight	≈ 190 g
Protection class	IP 20

Electrical parameter

Supply voltage	100 to 240 V AC, 50 to 60 Hz
Output voltage	24 V DC
Output current	max. 1 A
CAN termination	120 Ω terminal resistor integrated in D-Sub plug

Layout plan

Signal	Single-wire terminal	M 12 pin	D-Sub pin
U _B	Red	1	-
PGND/analogue input 1 GND	Black	2	-
Analogue input 1	White	3	-
CAN-H/analogue input 2	Yellow	4	2
CAN-L/analogue input 2 GND	Green	5	7



Caution

Risk of injury from electric shock if voltage is applied to the terminals.

Minor injury or burning

- Only have work performed on the electrical system by an electrically qualified person or by trained personnel working under the supervision of an electrically qualified person.
- Please note that incorrect assembly of electric cabling may result in material damage.

Further information

Additional versions

- CAN node type CAN-I0: D 7845 I0
- Proportional amplifier type EV1D: D 7831 D
- Proportional amplifier type EV1M3: D 7831/2
- Proportional amplifier type EV22K5: D 7817/2

Application

- Proportional directional spool valve, type PSL and PSV size 2: D 7700-2
- Proportional directional spool valve, type PSL, PSM and PSV size 3: D 7700-3
- Proportional directional spool valve, type PSL, PSM and PSV size 5: D 7700-5
- Proportional directional spool valve type PSLF, PSVF and SLF size 3: D 7700-3F
- Proportional directional spool valve type PSLF, PSVF and SLF size 5: D 7700-5F
- Proportional directional spool valve banks type PSLF and PSVF size 7: D 7700-7F
- Proportional directional spool valve type EDL: D 8086
- Proportional pressure-limiting valve type PDV and PDM: D 7486
- Directional seated valve type EM and EMP: D 7490/1
- Directional spool valve type NSWP 2: D 7451 N
- Variable displacement axial piston pump type V60N: D 7960 N
- Variable displacement axial piston pump type V30D: D 7960
- Variable displacement axial piston pump type V30E: D 7960 E
- Proportional pressure-limiting valve type PDV and PDM: D 7486
- Proportional flow control valve type SE and SEH: D 7557/1