

Proportional directional spool valve type PSL and PSV according to the Load-Sensing principle size 2 (valve bank design)

1. General

The directional spool valves types PSL and PSV serve to control both, the direction of movement and the load-independent, stepless velocity of the hydraulic consumers. In this way several consumers may be moved simultaneously, independently from each other at different velocity and pressure ratings, as long as the sum of the partial flows needed for this is within the total delivery supplied by the pump.

The proportional spool valves of this pamphlet are designed as valve banks and consist of three functional groups:

Basic data

Design	Proportional directional spool valve according to the Load-Sensing principle
Versions	Valve bank design
Pressure p_{max}	420 bar
Flow Q_{max}	40 (60) lpm

Table of contents

1. General information	1
2. Type coding, overview	2
3. Available version, main data	4
3.1 Connection blocks and end plates	4
3.2 Add-on spool valves	10
4. Characteristic data	17
4.1 General and hydraulic	17
4.2 Curves	18
4.3 Actuations	19
4.4 Functional cut-off, prop. pressure limitation	21
4.5 Other solenoid valves	21
5. Unit dimensions	22
5.1 Connection blocks and intermediate plates	22
5.2 End plates	26
5.3 Directional spool valves with manual actuation E0A, E0C and E0AR	27
5.4 Spool valves with actuation E and EA	28
5.5 Spool valves with actuation E0HA and EHA	29
5.6 Spool valves with actuation K	29
5.7 Lift monitoring	29
5.8 Spool valves with LS-pressure limitation, functional cut-off and prop. pressure limitation	30
5.9 Ancillary blocks	31
5.10 Intermediate plates for parallel connection	37
5.11 In series intermediate plate	39
6. Appendix	40
6.1 Notes for selection and lay-out	40
6.2 Circuit examples	44
6.3 Notes regarding assembly, installation and conversion	45

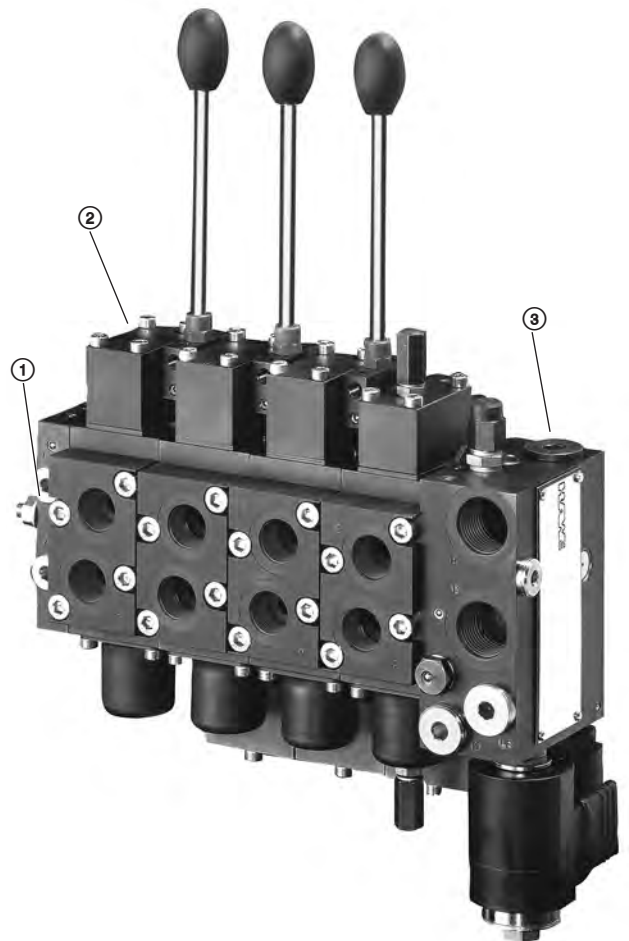

Further technical information:

Size	Design	Pamphlet
2	Valve bank design (CAN onboard)	D 7700 CAN
3	Valve bank design	D 7700-3
5	Valve bank design	D 7700-5
3, 5	Manifold mounting design	D 7700-F
7	Manifold mounting design	D 7700-7 F

Mounting

- ① End plate
- ② Directional spool valve
- ③ Connection block

2. Type coding, overview

Order coding example: (for additional examples, see also sect. 6)

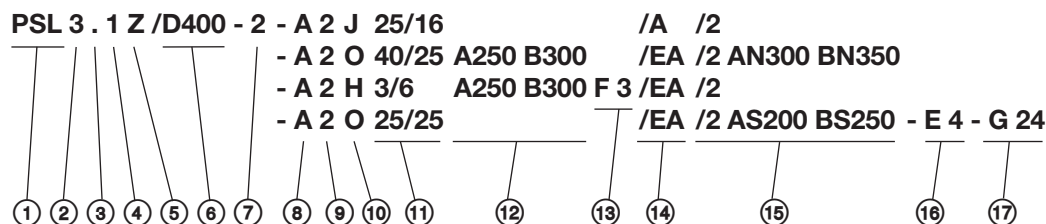

A total of max. 10 spool valves, in one or more valve bank(s), can be connected in series via the internal LS-duct. External piping is necessary (see also note at sect. 6.1 g) if more are requested.

- | | |
|--|--|
| <p>① Basic type code for the connection block (for detailed information, see sect. 3.1)</p> <p>PSL Supply with pressurized oil by means of constant delivery pump (open center)</p> <p>PSV Supply with pressurized oil by means of variable displacement pump (closed center) with a delivery flow controller, or as a second, separate unit if both valve banks are connected to a constant pressure system</p> <p>ZPL 52 Adapter plate enabling direct addition of sections size 2 to valve banks size 5 (acc. to D 7700-5)</p> <p>ZPL 32 Adapter plate enabling direct addition of sections size 2 to valve banks size 3 (acc. to D 7700-3)</p> <p>② Tapped ports P and R at the connection block</p> <p>3 G 1/2 conf. ISO 228/1 (BSPP)</p> <p>UNF 2 3/4-16 UNF-2B (SAE-8) conf SAE J 514</p> <p>③ Additional elements (acc. to section 3.1.1 and 3.1.2) (no coding) Basic version</p> <p>Optional types:</p> <p>S, W Additional damping device in gallery LS</p> <p>B, B 4..7 Orifice in gallery LS</p> <p>G Restrictor check valve</p> <p>N Integrated shut-off of the pump gallery (type PSV)</p> <p>H Raised circulation pressure of the 3-way flow controller (approx. 14 bar with type PSL)</p> <p>U, UH Automatic reduction of the pump idle circulation pressure by means of a by-pass valve</p> <p>Z Restrictor check valve + release valve (type PSL)</p> <p>④ Control oil supply (acc. to table 8, sect. 3.1.3) (no coding) Without pressure reducing valve in case of an external control oil supply via port Z (min. 20 bar up to max. 40 bar)</p> <p>1 With integrated pressure reducing valve for the internal supply of control oil (control pressure approx. 20 bar)</p> <p>2 With integrated pressure reducing valve for the internal supply of control oil (control pressure approx. 40 bar)</p> <p>⑤ Optional 2/2-way solenoid valve for arbitrary idle pump circulation (acc. to table 9, sect. 3.1.3) (no coding) Without directional valve, but prepared for retrofitting</p> <p>Z, ZM De-energized open = idle pump circulation when valve is de-energized</p> <p>V De-energized closed = idle pump circulation when valve is energized</p> <p>⑥ Tool adjustable pressure limiting valve (main pressure limitation) in the connection block (acc. to sect. 3.1.3, table 10)</p> <p>/D... Pressure limiting valve factory set to ... bar</p> <p>/... for type PSL...U</p> | <p>⑦ Size (acc. to the hole-pattern of the mounting area for the spool valves to be added)</p> <p>2 Size 2</p> <p>⑧⑨ Basic directional spool valve unit (acc. to table 13 and 22, sect. 3.2)</p> <p>A 2 Spool valve with inflow controller for each consumer</p> <p>A 1 Spool valve without inflow controller, suitable for consumers, which are actuated individually and successively but not simultaneously (no additional functions possible)</p> <p>A 5, A 7 Inflow controller with enforced spring for higher flow</p> <p>A 8 4/3-way directional spool valve (pre-selector valve)</p> <p>AR 2, AR 5, AR 7 Like A 2, A 5, A 7 but with additional check valve function</p> <p>A1 RR PV.PV Lifting / lowering module</p> <p>⑩ Coding for the flow-pattern (for additional information, see sect. 3.2.1, table 14 and sect. 6.1 c)</p> <p>L, M, F, H, J, B, R, O, I, Y, V, W, G</p> <p>⑪ Flow coding for outlet A and B (acc. to table 15, sect. 3.2.1)</p> <p>.../... Coding for outlet A or B (independently selectable) 3, 6, 10, 16, 25, 40</p> <p>⑫ LS-pressure limitation (deviating from the main pressure setting, lower pressure for the connected consumer) no shock valves (see table 16, sect. 3.2.1), doesn't apply to spool valve types without inflow controller, coding 1 ⑨ or table 13</p> <p>(no coding) No LS-pressure limitation</p> <p>A... Only for consumer port A</p> <p>B... Only for consumer port B</p> <p>A... B... For consumer ports A and B</p> <p>⑬ Functional cut-off (acc. to table 17, sect. 3.2.1), doesn't apply to spool valve types without inflow controller, coding A 1 ⑨ or table 13 only in combination with LS-pressure limitation</p> <p>A.. B.. ⑫</p> <p>(no coding) No functional cut-off</p> <p>FP 1 Functional cut-off for port A plus prop. pressure limitation</p> <p>FP 2 Functional cut-off for port B plus prop. pressure limitation</p> <p>FP 3 Functional cut-off for port A and B plus prop. pressure limitation</p> <p>FPH 1(2, 3) Like FP 1(2, 3), however with additional push-button for manual emergency actuation</p> <p>S 1 External hydraulic load signal pick-up from the control signal port U (consumer port A) and W (consumer port B)</p> |
|--|--|

- ⑭ Types of actuation (acc. to table 20 and 21, sect. 3.2.1)
- | | |
|--------------------|---|
| /E0A | Manual actuation (prepared for retrofitting of an actuation solenoid) |
| /E0C | Detent (stepless) |
| /E0AR, EAR | Electrical, 3-step detent (with/without manual actuation) |
| /E | Electro-hydraulic actuation |
| /EA | Electro-hydraulic and manual actuation |
| /EHA | Hydraulic, electro-hydraulic and manual actuation |
| /HA | Hydraulic actuation and manual actuation |
| /K | Mech. joy-stick (2-axis) |
| /... Suffix | 1 without hand lever |
| | WA Integrated travel indicator |
| | U Lift monitoring (side indication) |
| | S Seaworthy version |
| | VCHO, Contact switch detecting |
| | VCHC the spool elevation |
- ⑮ Ancillary blocks (acc. to table 19 in sect. 3.2.1), in combination with codings A of ⑩
- | | |
|---|--|
| /2, /3, /UNF 2 | Ancillary blocks without additional functions |
| /2 AS.. BS.., /UNF 2 AS.. BS.. | Ancillary blocks with shock valves at A and B (routed to the opposing side), with pressure specification (bar) |
| /2 AN.. BN.., /UNF 2 AN.. BN.. | Ancillary blocks with shock and suction valves at A and B, with pressure specification (bar) |
| /UNF 2 AN.., /UNF 2 BN.. | Ancillary blocks with shock and suction valves at A or B, with pressure specification (bar) |
| /2 AL.. BL.., /UNF 2 AL.. BL.. | Ancillary blocks with over-center valves at A and B, with pressure specification (bar) |
| /2 AL.., /2 BL.., /UNF 2 AL.., /UNF 2 BL.. | Ancillary blocks with over-center valves at A or B, with pressure specification (bar) |
| /2 DRH, /UNF 2 DRH | Ancillary blocks with releasable check valves |
| /32 DFA, /32 DFB | Ancillary blocks for regenerative circuitry |
| /3 AVT, /3 BVT | Stop valve at A or B with emergency drain valve |
| /2 A(B) HN | Ancillary block with emergency drain |
- ⑮a Intermediate plates (acc. to table 19 a, sect. 3.2.1)
- | | |
|--------------------|---|
| /ZSS, /ZV | Intermediate plates with bypass valves |
| /ZDR, /ZDS | Short-circuit valve between A and B |
| /ZAL.. BL.. | Intermediate plates with over-center valves at A and B, with pressure specification (bar) |
| /Z 2 A(B).. | Intermediate plate with additional port |
| /ZDRH | Intermediate plate with releasable check valves |
| /Z 40 | Spacer plate |
| /ZANBN | Intermediate plate with suction valves |
| /ZVX, /ZXV | Intermediate plate with shut-off valves in A or B |
- ⑯ End plate (acc. to table 11, sect. 3.1.5)
- | | |
|----------------------|---|
| E 1 | With T-port for external control oil return to the tank (standard) |
| E 2 | Like E 1, with additional port Y for connection to the LS-port of a further, separately located PSV spool valve |
| E 4 | Like E 1, however internal return control oil return, max. pressure 10 bar! |
| E 5 | Like E 2, however internal return control oil return, max. pressure 10 bar! |
| E 17 ... E 20 | Variations, acc. to table 11 in sect. 3.1.5 |
| E 17 UNF ... | Like E 17 or E 20, port thread 3/4-16 UNF-2B |
| ... E 20 UNF | (SAE-8) conf. SAE J 514 (for port size see sect. 5.2) |
- ⑰ Solenoid voltage and version (acc. to table 3, sect. 3.1.1)
- | | |
|-------------------|--|
| G 12 | 12V DC, connection conf. DIN EN 175 301-803 A |
| G 24 | 24V DC, connection conf. DIN EN 175 301-803 A |
| G 24 C 4 | 24V DC, connection conf. DIN EN 175 301-803 C |
| AMP 24 K 4 | 24V DC, connection via AMP Junior Timer |
| DT 12 | 12V DC electr. connection via plug Co. DEUTSCH |
| DT 24 | 24V DC electr. connection via plug Co. DEUTSCH |

3. Available versions, main data

3.1 Connection blocks and end plates

There are two basic variations of connection blocks:

- Connection blocks with integrated 3-way flow controller, suitable for a constant delivery pump system (open-center) - type PSL (see sect 3.1.1)
- Connection blocks suited for a variable displacement pump system (closed center), a constant pressure systems, or if a second or more separately located directional spool valve banks are fed in parallel - type PSV (see sect 3.1.2).

Order coding for a connection block as single section (examples: **PSL 31 Z/250 - 2 - G 24**
(Attention: Size specification absolutely necessary, here -2)

3.1.1 Connection blocks for constant delivery pump systems (with integrated 3- way flow controller) type PSL

Order example: **PSL 3 . 1Z/D300 - 2 - ... - E 1 - G 24**



Table 1: Basic type and port size

Coding	Port P and R conf. ISO 228/1 (BSP) or SAE J 514	Max. pump delivery flow (lpm)	Description
PSL 3	G 1/2	approx. 80	Standard, integrated 3-way flow controller
PSL UNF 2	3/4-16 UNF-2B (SAE-8)		
PSL 3 U	G 1/2	approx. 100	Automatic reduction of the idle pump circulation pressure by means of a by-pass valve. With solenoid actuation: $Q_{pu} \geq 60$ lpm
PSL UNF 2 U	3/4-16 UNF-2B (SAE-8)		
PSL 3 Z	G 1/2	approx. 80	Version with additional release valve for the LS-line enabling a special dampening characteristic (quick pressure release during idle position of all valve sections). Used best in combination with dampening elements coding W or K, acc. to table 2.

Note: A spacer plate type SL 2 - ZPL 22/7 (see table 22) has to be installed right after the connection block whenever type PSL 3 Z is combined with a valve section with ancillary block (coding SL 2-A.. acc. to table 23) as otherwise it is not possible to mount a fitting in port R.

Flow pattern symbols (see also sect. 3.1.3)

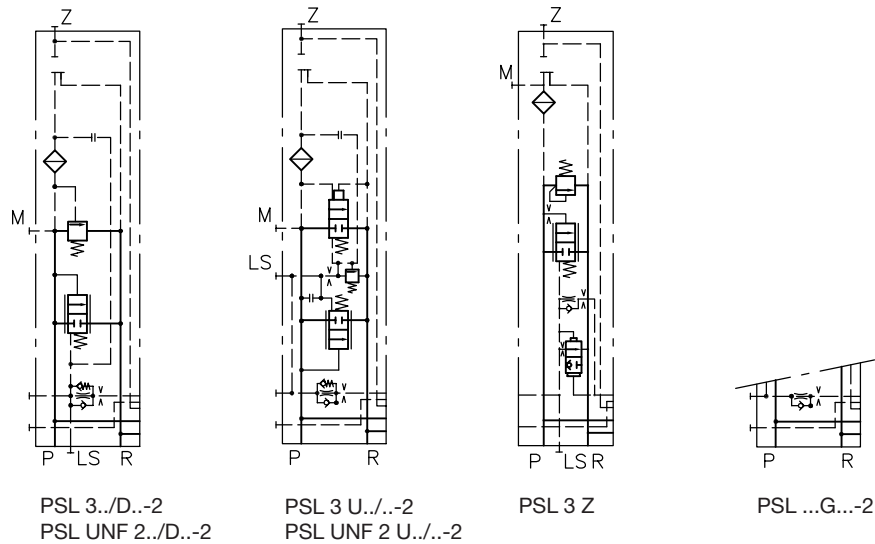

Table 2: Coding for additional elements (for notes and descriptions, see sect. 6.1 a)

Coding	Description
no coding	Standard (integrated combination of orifice, check valve, pre-load valve pre-load pressure approx. 25 bar)
W	Like standard, but with increased throttling
G	Restrictor check valve (without sequence valve), increased throttling effect
K	Stepped throttle, with temperature independent characteristic. Only available for type PSL 3 Z.
H	Code letter for 3-way flow controller with increased circulation pressure (see sect. 4.2), otherwise similar symbol as standard type e.g. if spool valves with increased flow rate are used (coding .5 acc. to table 15)
T	Provision for locking the 3-way flow controller to enable use with variable pump systems. Only available for type PSL 3 Z
TR	Like T, manually adjustable

Table 3: Solenoid voltage and version

Coding	Description
G 12 . G 24 T without T TH	Electr. connection conf. DIN EN 175 301-803 A, via plug (MSD 3-309) Suffix: Applies only to the solenoid actuation coding E, EA, EHA, EFA (table 20) and the functional cut-off (coding F, FP, table 17), see also sect. 4.3 Actuation solenoid 3-pin (standard) Manual emerg. actuation (standard with functional cut-off F., FP., see table 17) Manual emerg. actuation with pushbutton (standard with functional cut-off FPH., FP., see table 17)
G 24 C 4	Electr. connection conf. DIN EN 175 301-803 C, via plug (MSD 6-209), 4-pin actuation solenoid
X 12 . X 24 .	Electr. connection conf. DIN EN 175 301-803 A, without plug. For options, see coding G...
S 12 S 24	Electr. connection via quarter turn type plug (Bayonet PA 6 ®, Co. SCHLEMMER D-85586 Poing, suited for taper with bayonet 10 SL), 3-pin actuation solenoid
AMP 12 K 4 AMP 24 K 4	Vertical connection via plug AMP Junior Timer, solenoid features 4 terminals
DT 12 DT 24	Connection via plug Co. DEUTSCH DT 04-4P, suited for socket DT 06-4S
Note:	<ul style="list-style-type: none"> ● Coding G 24 C 4 (X 24 C 4) only available for actuations without E, EA, EH (A) (table 20) ● Coding AMP..., DT not available for idle circulation valves coding D, F (table 9), functional cut-off coding F. (table 17) ● Coding S.. not available for functional cut-off (table 17) and comparator coding WA or U (table 21)

3.1.2 Connection blocks for variable displacement pump systems / constant pressure system or for a second and all other separately parallel connected directional spool valve banks type PSV

Order example:

PSV 3 .1 Z/D300 - 2 -...- E 1 - G 24

Nom. voltage, see table 3
sect. 3.1.1

Table 4: Basic type and port size

Coding for additional elements
table 5

Coding	Port P and R conf. ISO 228/1 (BSPP) or SAE J 514	Max. pump delivery flow (lpm)
PSV 3	G 1/2	approx. 80
PSV UNF 2	3/4-16 UNF-2B (SAE-8)	
PSV 4 N	G 3/4	approx. 100
PSV UNF 4 N	1 1/16-12 UN-2B (SAE-12)	

Flow pattern symbols (see also sect. 3.1.3)

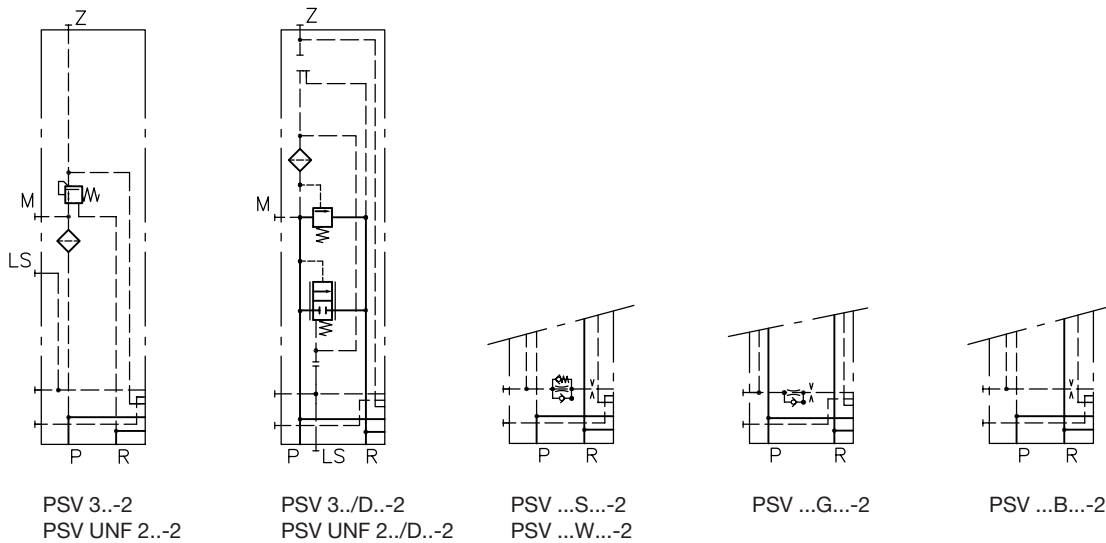

Table 5: Coding for features within the LS-signal duct for the damping of pump flow controllers (for notes and explanation, see sect. 6.1)
Additional features only suitable where variable displacement pumps are used (limitation of the control oil flow)

Coding	Description
no coding	Standard , without additional element
S	With integrated combination of orifice, check valve, pre-load valve (pre-load pressure approx. 25 bar); like standard element of type PSL
W	Like S, but with increased throttling
B	With orifice \varnothing 0.8 mm within LS-duct (to limit control oil flow)
B 4 B 5 B 6 B 7	With orifice \varnothing 0.4 mm, 0.5 mm, 0.6 mm, 0.7 mm in the LS-gallery

Divergent type coding at type PSV 4 N or PSV UNF 4 N

Order example: **PSV 4 N S 1 300/270 - 2**
PSV 4 N S 2 V 250/210 - 2
PSV 4 N S Z 350/310 - 2

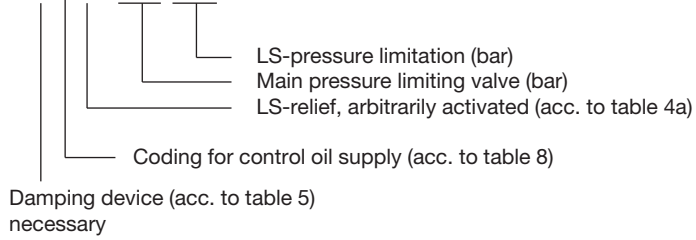
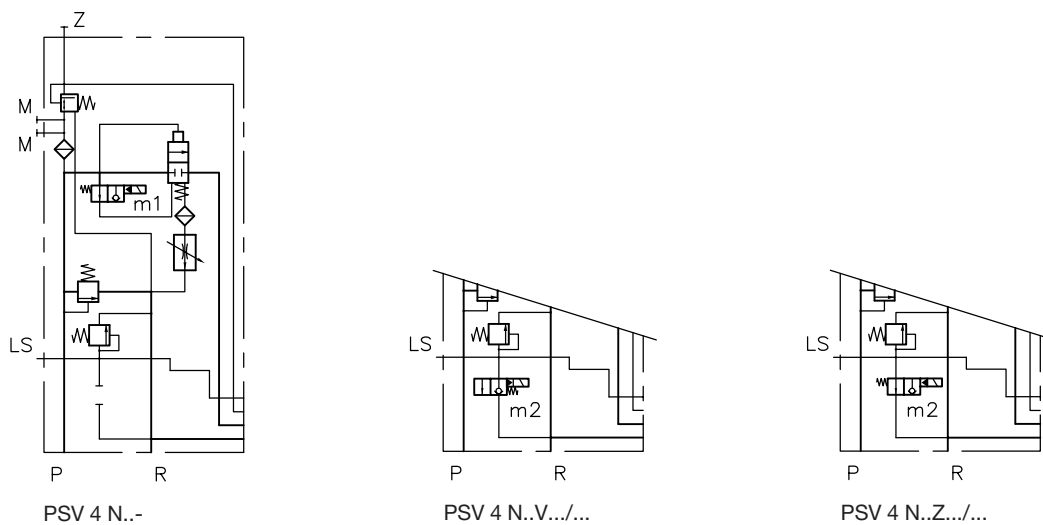

Table 4a: LS-relief

Coding	Description
no coding	Without arbitrary relief, prepared for retrofitting of a directional seated valve type EM 11 S(V) acc. to D 7490/1
V	With 2/2-directional seated valve type EM 11 V acc. to D 7490/1 (closed when deenergized)
Z	With 2/2-directional seated valve type EM 11 S acc. to D 7490/1 (open when deenergized)

The high control pressure of variable displacement pump controllers may lead to unintentional movements of consumers with low load pressure even while the respective valve is in its idle position. The pump gallery is completely blocked with type PSV 4 N to ensure a definitive separation of pump and consumer circuit. This takes place by means of a solenoid valve. The LS-gallery together with the LS-controller may be additionally relieved via a separate 2/2-way directional seated valve.

Flow pattern symbols



3.1.3 Additional elements for the connection blocks

Order examples: PSL 3. **1 Z /D 380** - 2 -...- E 1 - G 24

PSV 3 S **1 Z /D 350** - 2 -...- E 1 - G 24

PSL 3 U **2 V / 320** - 2 -...- E 4 - G 24

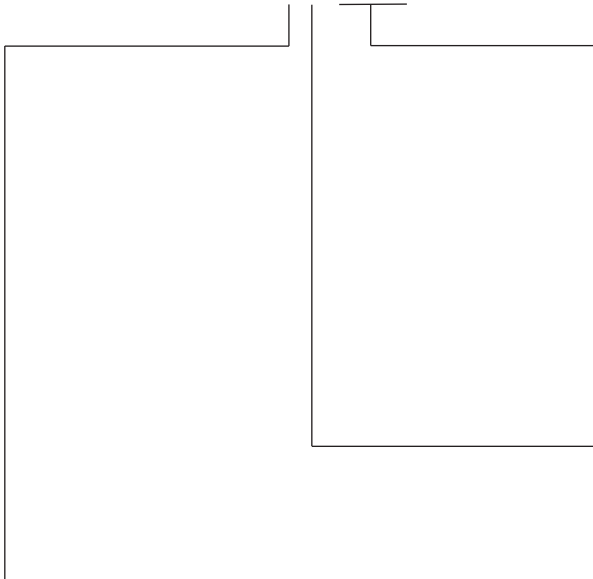

Table 8: Coding for control oil supply
(for symbol, see sect. 3.1.1 and 3.1.2)

Coding	Description
no coding	Without pressure reducing valve for actuation E0A or E0C acc. to sect. 3.2 table 17 or in the case of external control oil supply (20...40 bar) for other actuations
1	With integrated pressure reducing valve for internal control oil supply for actuations HA... and E(EA).. or as pick-up for other control valves (max. permissible control oil flow approx. 2 lpm) Control pressure: Coding 1: approx. 20 bar (+ return pressure at R) Coding 2: approx. 40 bar (+ return pressure at R)
2	

Table 10: Tool adjustable pressure limiting valve for the main pressure.
Adjustable from 50 up to 420 bar, after loosening the lock-nut (for symbol, see sect. 3.1.1 and 3.1.2).

Coding	Description
no coding	Version without pressure limiting valve (only type PSV)
/D...	With piloted pressure limiting valve at type PSL and PSV (pressure specification in bar)
/...	Piloted pressure limiting valve at type PSL ... U

Table 9: Arbitrary idle pump circulation of all consumers by means of 2/2-way solenoid valve acc. to D 7490/1 E

Note: To limit the control oil flow, when using the idle pump circulation with type PSV an additional element coding S, W or B 4, B 5, B 6 acc. to table 5 is required.

Attention: Observe note in sect. 6.1 a when using the valves for an emergency stop function!

Coding	Description
no coding	Prepared for retrofitting
Z	With type EM 21 DSE, idle pump circulation if valve is de-energized (emergency stop)
ZM	Like Z, but with lead sealed wing screw for emergency operation
V	With type EM 21 DE, idle pump circulation if valve is energized
F	With type WN 1 F, idle pump circulation if valve is energized (emergency stop) (only type PSL 3 Z)
D	With type WN 1 D, idle pump circulation if valve is energized (only type PSL 3 Z)

Flow pattern symbols

Pressure reducing valve

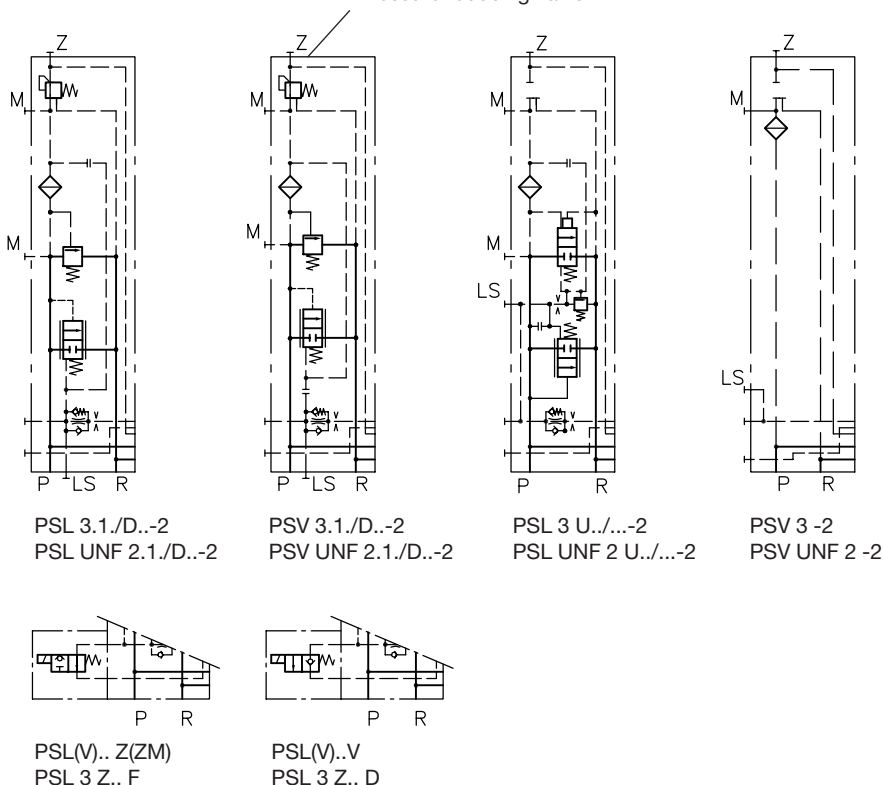

3.1.4 Adapter plates

Order examples: PSL 41/D250-3 - 42 H 80/63 /EA

- **ZPL 32**

- A 2 L 25/16 /EA/2 - E 4 - G 24

Coding	Brief description	Symbol
ZPL 32	Adapter plate from prop. directional spool valve bank size 3 (acc. to D 7700-3) to size 2.	
ZPL 52	Adapter plate from prop. directional spool valve bank size 5 (acc. to D 7700-5) to size 2.	

3.1.5 End plates

Order example: PSL 31 Z /D380 - 2 - ... - **E 1** - G 24

Table 11: End plates

End plate		Ports	Description
external port T (separate return pipe to the tank)	internal control oil return gallery		
E 1	E 4	ISO 228/1 (BSPP): T, Y = G 1/8 P and R = G 3/8	Order coding of an end plate as separate part (example): SL 2 - E 1
E 2	E 5		Standard end plate
E 17 E 17 UNF	E 19 E 19 UNF	SAE J 514 (E.. UNF): T, Y = 7/16-20 UNF-2B (SAE-4) P and R = 3/4-16 UNF-2B (SAE-8)	With additional inlet port Y e.g. for connecting the LS-control pipe of a subsequent PSV spool valve bank.
E 18 E 18 UNF	E 20 E 20 UNF		Like E 1/E 4, but with additional port P and R
			Like E 2/E 5, but with additional port P and R
Note: The internal control oil return gallery is to be used only in systems where the return pressure is below 10 bar			

Flow pattern symbols

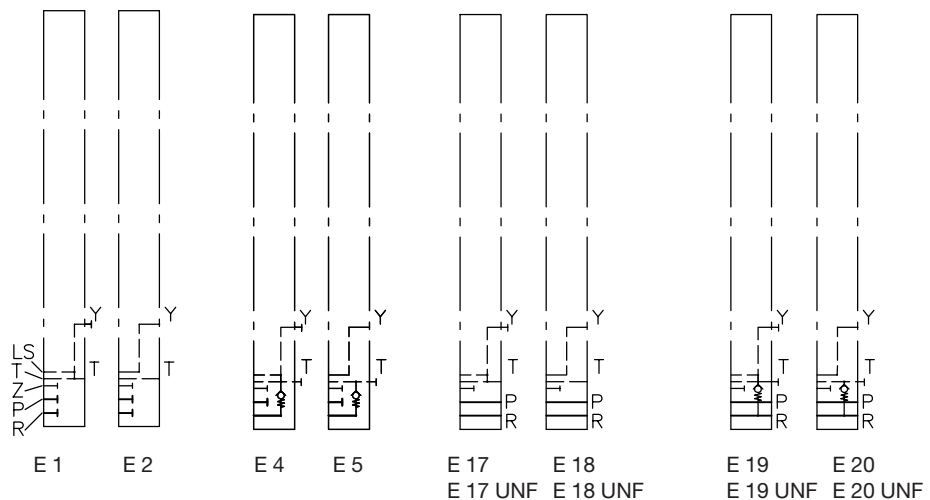

3.2 Add-on spool valves

3.2.1 Directional spool valve

Order example: PSV 31/D380 - 2 - **A 2 L 25/40 A 300 F 1** /EA /2 - E 1 - G 24

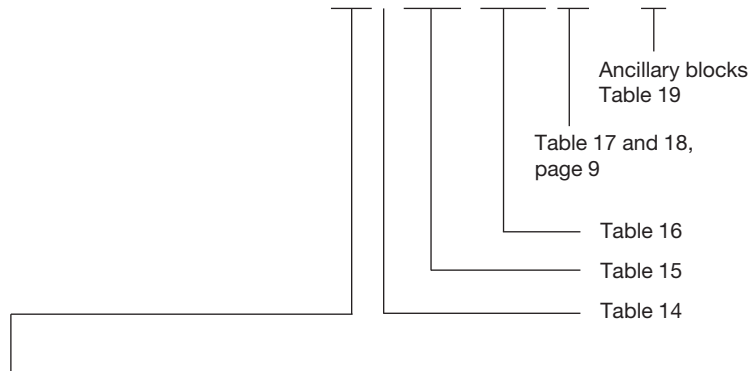
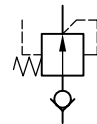

Table 13: Directional spool valve, basic unit

Coding	Description
A 2	Standard , with inflow controller, for simultaneous load compensated moving of several consumers (3/3-, 4/3-way spool valve, standard type, control pressure approx. 6 bar)
A 1	Without inflow controller intended for singly / successively actuated functions. Additional functions on the consumer side are not possible. For the max. consumer flow of the indiv. consumer, see table 15 and note in sect. 6.1 b)
A 5	With inflow controller (for symbol, see coding A 2) but with reinforced spring at the 2-way flow controller (control pressure approx. 9 bar). Only usable in conjunction with connection block type PSL.H./... or type PSV with variable displacement pump / constant pressure system. For note, see sect. 6.1 a).
A 7	With inflow controller (for symbol, see coding A 2) but with reinforced spring at the 2-way flow controller (control pressure approx. 13 bar). Only usable in conjunction with connection block type PSV and variable displacement pump / constant pressure system. (For note, see sect. 6.1 b)
A 8	4/3-way directional spool valve, utilized as pre-selector (also, see symbol page 13). This version is only recommended with flow coding L or H and max. flow. Only usable in combination with connection block type PSL.H./... or type PSV with variable displacement pump / constant pressure system. (For note, see sect. 6.1 b)
A 81	Like coding 81, but without LS signal input from consumer port B into the main LS-gallery
AR 2 AR 5 AR 7	Like A 2, A 5, A 7; but with check valve function (spool valve = slight leakage), see also sect. 6.1 b



Order coding for indiv. valve section (example):

Directional spool valve

SL 2-A 2 J 25/40 F 2/EA/2-G 24

Valve spools (alone)

SL 2 - J 25/40

Note:

Size specification **SL 2** is mandatory! The valve spools are subsequently interchangeable, e.g. if a different flow rating than initially planned becomes necessary (see sect. 6.3.4)

Table 14: Coding for flow pattern

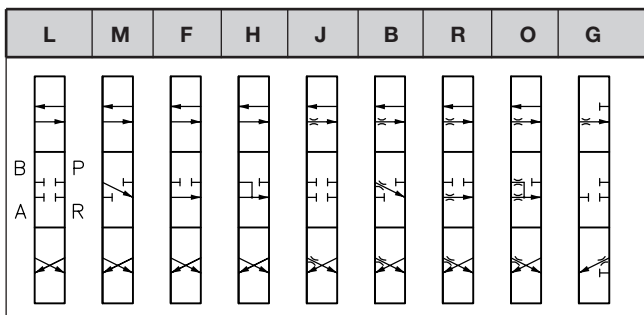

J, B, R, O, I, Y, V	Spool with return flow throttling to support the oscillation damping, see sect. 6.1 c
W	4/2-way directional spool valve, see sect. 6.1 c
G	3/3-way directional spool valve, see sect. 6.1 c
HW, OW	Valve spool with wider fitting to prevent spool sticking - intended for contamination prone systems
X	4/2-way directional spool valve for hydraulic motors, see sect. 6.1 c

Table 15: Max. flows P → A(B) acc. to the coding

Valve spool coding acc. to table 13	Coding for consumer flow $Q_{A, B}$ (lpm) at ports A and B 1)					
	3	6	10	16	25	40
2	3	6	10	16	25	40
1	4	9	14	22	34	54
	Valid for PSL (integrated 3-way flow controller: $\Delta p \sim 9$ bar) otherwise as guide line $Q_{A, B} \approx Q_{nom} \cdot \sqrt{0.2 \cdot \Delta p_{controller}}$ Q_{nom} -flow for coding 1 $\Delta p_{controller}$ stand-by-pressure of the flow controller of the pump Example: $Q_{nom} = 16$ lpm, $\Delta p_{controller} = 25$ bar $Q_{A, B} \approx 36$ lpm					
5	4	9	14	22	34	54
7	5	10	15	24	38	60
8, 81	See coding 1 B-side should be rated with coding 40, e.g. L 10/40					

The flow ratings for the consumer ports A and B can be selected freely, e.g. 25/40, 6/16. Thereby enabling optimal adaptation to the respective consumer while exploitation the full functional lift of the spool. In addition there is the possibility of stroke limitation.

Table 17: Functional cut-off plus prop. pressure limitation (only available for spool valves with inflow controller coding 2, 5 and 7 acc. to table 15!)
Only in combination with pressure limitation coding A.. and/or B.. acc. to table 16!

Coding	Description
no coding	Without functional cut-off
FP 1, FP 2, FP 3 FPH 1, FPH 2, FPH 3	Prop. pressure limitation for A or B resp. A and B Version FPH. with additional emergency actuation (no tools needed)
S 1	Load signal ports U and W (G 1/8 (BSPP)) for external piping

There remains a residual pressure when the LS gallery is relieved. When the return line is depressurized the residual pressure will be:
 $P_{relieved} = \Delta p_{valve} + \Delta p_{controller}$ ($\Delta p_{controller}$ = control pressure of the inflow controller acc. to table 13)
 Coding FP.: $\Delta p_{valve} = 25$ bar
 Coding S 1: $\Delta p_{valve} = 15$ bar

Table 16: LS-pressure limiting valves, no shock valves (only with spool valves featuring a inflow controller, coding 2, 5, and 7 acc. to table 15 !)

Coding	Description
no coding	Without pressure limitation
A...	Pressure limitation at A with pressure specification
B...	Pressure limitation at B with pressure specification
A...B...	Pressure limitation at A and B with pressure specification
Pressure limitation $p_{min} = 50$ bar; $p_{max} = 400$ bar Example: SL 2-A 2 H 25/40 A 250 B 200/A/2	

Table 18: Combination possibilities for additional functions

Pressure limitation	Functional cut-off		
	no coding	S 1	FP 1, FP 2, FP 3 FPH 1, FPH 2, FPH 3
no coding	•		
A or B A and B	•	•	•

Table 19: Ancillary blocks

Port size: /2.. = G 3/8 (ISO 228/1) (BSPP), /3.. = G 1/2 (ISO 228/1) (BSPP), /UNF 2.. = 3/4-16 UNF-2B (SAE-8)

Coding	Brief description	Symbols
/2, /2 M /UNF 2, /UNF 2 M /3 /22	Without additional functions (/2 M, /UNF 2 M with pressure gauge ports, /22 with further spread ports)	
/2 AS... BS... /22 AS... BS... /UNF 2 AS... BS...	With shock valves at A and B (routed to the opposing side), with pressure specification (bar) (/22 AS... BS... with further spread ports)	
/2 AN.. BN.. /UNF 2 AN... BN... /22 AN... BN...	With shock and suction valves at A and B, with pressure specification (bar) (/22 AN... BN... with further spread ports)	
/UNF 2 AN... /UNF 2 BN...	With shock and suction valves at A or B, with pressure specification (bar)	
/2 DRH /UNF 2 DRH	With double check valve, opening pressure: 0.4 p _{A, B} + 3 bar	
/32 DFA /32 DFB	With regenerative circuit functionality to spool side A (type /32 DFA) or spool side B (type /32 DFB) Attention: Not suited when pulling loads are anticipated!	
/3 AVT /3 BVT	Stop valve type EM 22 V acc. to D 7490/1 at A or B with emergency function Note: The manual emergency actuation can be only activated below 100 bar!	
/2 A HN /2 B HN	With manual short-cut valve between A and B as well as drain valve for A or B to the tank	
/2 AL-0-... /2 BL-0-... /UNF 2 AL-0-... /UNF 2 BL-0-... /2 AL-0-... -BL-0-... /UNF 2 AL-0-... -BL-0-... /2 ALX-0-... -BLX-0-... /UNF 2 ALX-0-... -BLX-0-...	With over-center valves at A and B, with pressure specification (bar); For more details, see D 7918 type LHT 2. Attention: - Observe Q _{max} of the over-center valve! - Type /...2 ALX ... BLX ... Pressure adjustment by means of washers - Type /... 2 AL ... BL can be combined only with intermediate plates (coding ZPL .. acc. to table 19 a) and actuation suffix .. WA or U can be combined	

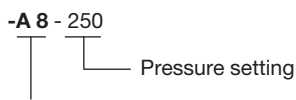

Recommended flow (lpm) / Release ratio

Coding	1:8	A 8	B 8	C 8	D 8	E 8
	1:4	A 4	B 4	C 4	D 4	E 4
lpm		28	14	10	6	3

Order example:

PSL 31 Z/D300 - 2 - A 2 H 16/16 /EA /2 AS 220 BS 220 - E 4 - G 24

Ancillary blocks

Valve section suited for mounting of an ancillary block

Table 19 a: Intermediate plate between basic valve body and ancillary block

Intermediate plates	Brief description	Symbols
/Z 40	Spacer plate 40 mm, suited to compensate height differences of the various ancillary blocks	
Z ANBN	With suction valve for A and B	
/ZSS /ZVV	With bypass valves type EM 21 V or EM 21 S acc. to D 7490/1 for arbitrary relief of all consumers	/ZSS /ZVV
/ZVX /ZXV	With shut-off valve type EM22 acc. to D 7490/1 for zero-leakage blocking of consumers (Q _{max} approx. 40 lpm)	
/ZDR /ZDS	Intermediate plate with short-cut valve between A and B (floating function) for volume interchange Q _{max} = 20 lpm	/ZDS /ZDR
/Z 2 A R B... /Z 2 A S B... /Z 2 B R B... /Z 2 B S B...	Intermediate plate with additional port S, arbitrarily switchable With orifice for flow restriction Orifice diameter 0.4, 0.5, 0.6, 0.7, 0.8, 0.9, 1.0, 1.2, 1.5 (Q _{max} = 15 lpm)	/Z 2 A R B... /Z 2 A S B... /Z 2 B R B... /Z 2 B S B...
/ZDRH	With releasable double check valve, open-up pressure 0.4 p _{A, B} + 3 bar	
/ZAL-0-... /ZBL-0-... /ZAL-0-...-BL-0-... /ZALX-0-...-BLX-0-...	Intermediate plate with over-center valve, like ancillary block /2 AL-0-...BL-0-... Note: Type /ZAL.. can not be combined with actuation suffix ..WA or U	/ZAL-0-...-BL-0-... with bypass-orifice D2 /ZAL-...-...-BL-...-... /ZAL-... /ZBL-...

Flow coding and pressure setting, see ancillary block /2 AL-0-...BL-0-..

Bypass-orifice D2

Coding	0	3	4	5	6	7	
(∅ mm)	plugged	0.3	0.4	0.5	0.6	0.7	
Release ratio	.4	1:4	1:3.04	1:2.0	1:1.16	1:0.66	1:0.39
	.8	1:8	1:6.08	1:4.0	1:2.32	1:0.77	1:0.47

**Basic version
acc. to table 13**

With respect to flow configuration and actuation, these symbols are neutral and must be supplemented by the corresponding flow pattern symbols illustrated in table 14, 19 or 20, see also example in table 19 and sect. 6.

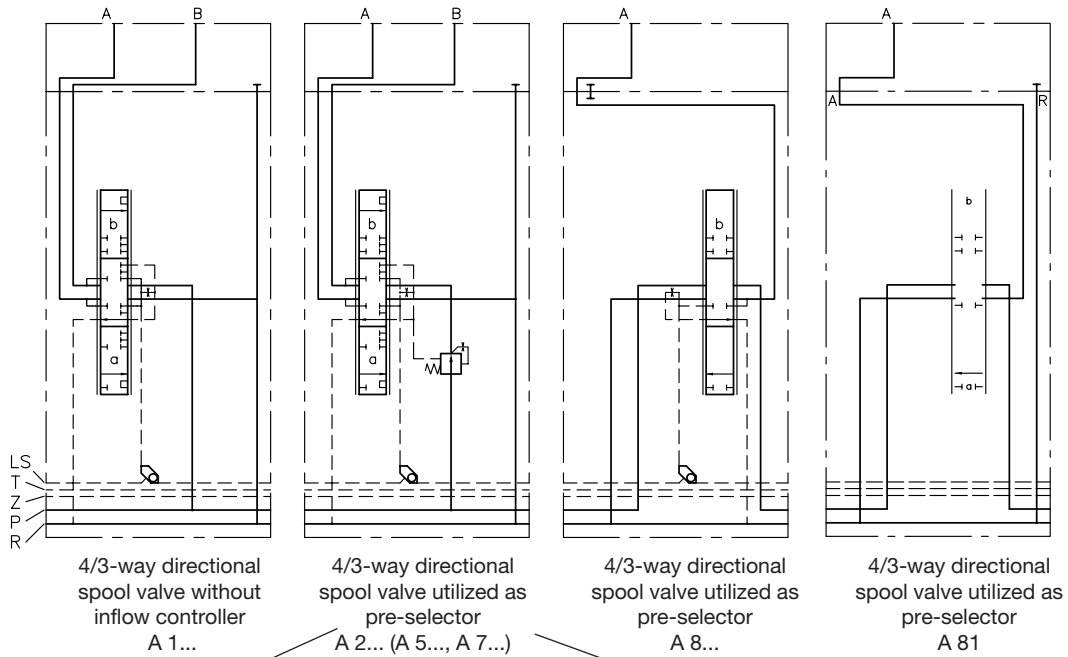

Additional function

LS-pressure limitation acc. to table 16 for spool valves with inflow controller (no shock valve!)

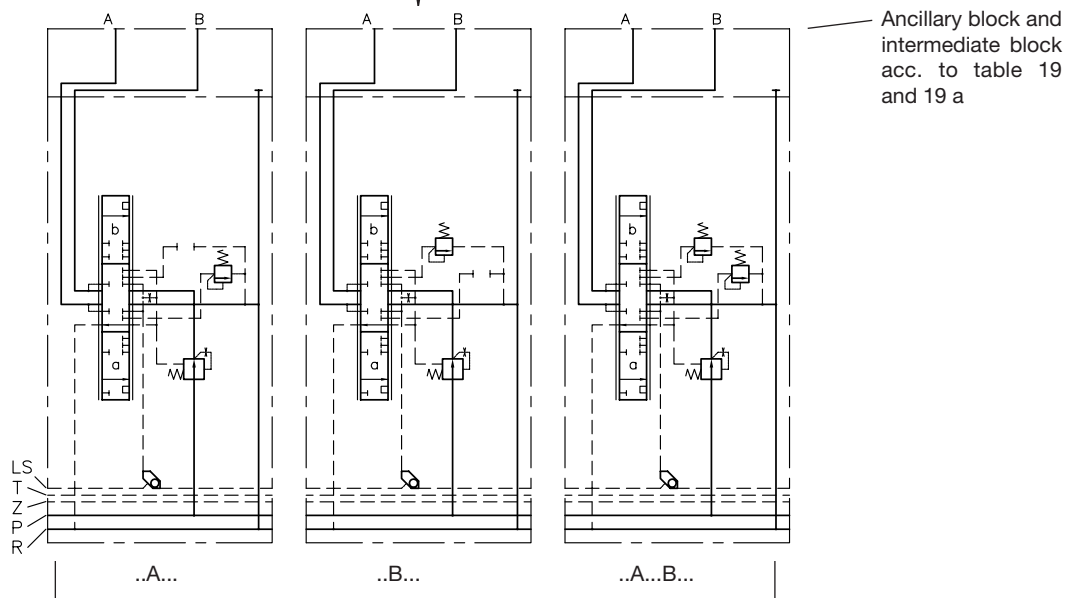

Functional cut-off

acc. to table 17, for spool valves with inflow controller

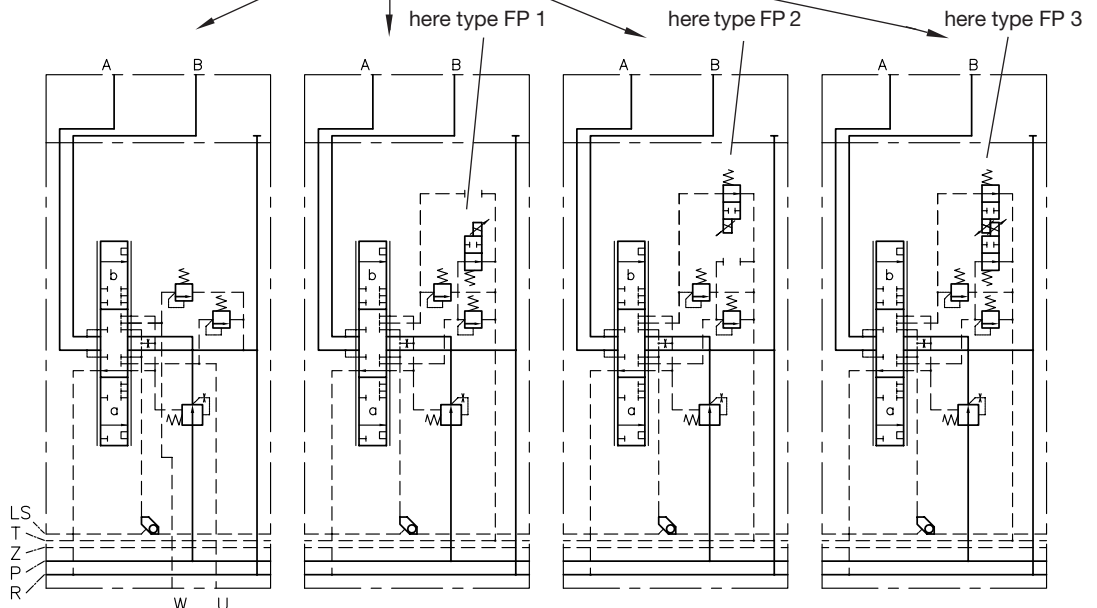

Combination possibilities

- | | | | |
|-----------|-------------------|-------------------|-------------------|
| A..S 1 | A..FP 1, FPH 1 | A..FP 2, FPH 2 | A..FP 3, FPH 3 |
| B..S 1 | B..FP 1, FPH 1 | B..FP 2, FPH 2 | B..FP 3, FPH 3 |
| A..B..S 1 | A..B..FP 1, FPH 1 | A..B..FP 2, FPH 2 | A..B..FP 3, FPH 3 |

Table 20: Types of actuation (for further explanations, see sect. 4.3)

Nomenclature	Manual actuation		Electro-hydraulic actuation			Hydraulic actuation		Mechanical 2-axis joystick
	Spring return	Detent	Purely electro-hydraulic	Combined with manual actuation	CAN-onboard	Combined with manual actuation	Combined with solenoid and manual actuation	
Coding	E0A	E0C E0AR	E EI ER	EA EAR	E-CAN	E0HA	EHA (EH)	K KE
Symbols								
Manipulated variables	Actuation angle min. approx. 5° max. approx. 30°		Control current ratio I/I _N min. approx. 0.2 max. approx. 1		Protocol: CAN- open, J 1939	Control pressure min. approx. 5 bar max. approx. 18 bar max. perm. 50 bar		Actuation angle approx. 5...19°

- Note:**
- Approximate values for start of flow at A or B (= min) up to max. consumer flow according to the flow coding table 15, see curves sect. 4.2.
 - With actuations EH(A) observe also notes and circuit examples in sect. 6.1 i
 - Type E0A, E0C, E0AR is prepared for retrofitting solenoid actuations
 - Type E0AR, ER and EAR come with detent in the end positions, stroke limitation not possible
 - Type EI - Version without stroke limitation
 - Type EM and EAM: Version with pressure gauge ports at the actuation heads
 - Type A 8: Actuation torque like with EA; Type E 9, E 9 A: Actuation torque like with E0HA
 - Type E-CAN: For details, see D 7700 CAN

Table 21: Additional features for actuations

Type of actuation / coding	Suffix	Description	Examples	Symbols
E0A, EA, HA	1	Manual actuation without hand lever	EA 1	
E0A, EA, HA, E0C	VCHC VCH0	VCHC - An indiv. signal for A- or B-side is triggered when the spool is elevated (2xNC-contact) VCH0 - An indiv. signal for A- or B-side is triggered when the spool is elevated (2xNO-contact)	EA VCH0	
E0A, EA	WA	Integrated position sensor (Hall-sensor) with analogous signal output (lift monitoring)	EA WA, A 1 WA	
E0A, EA	U	Integrated position sensor indicating the movement direction (signal output: on/off) Attention: This option is not possible in the first valve section, when there is a idle circulation valve at the connection block (coding V, Z, or ZM), as the electric field, generated by the EM-solenoid, will influence the function of the sensor. A flow limitation is only available for port A, when combined with actuation coding EI!	EAU	
EA	S	Seaworthy version, see also sect. 6.1 d	EAS	

3.2.2 In series intermediate plates

Order example: PSL 3 U 1/D 230-2
 - A 1 RR PV PV /4
 - A 2 L 25/16 /E
 - E 4 - G 24

Table 22: In series intermediate plates

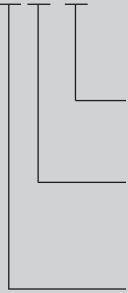
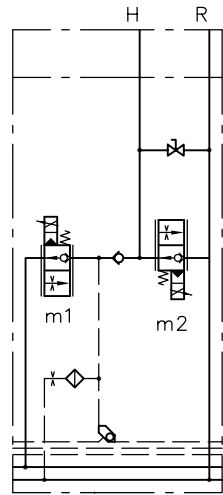
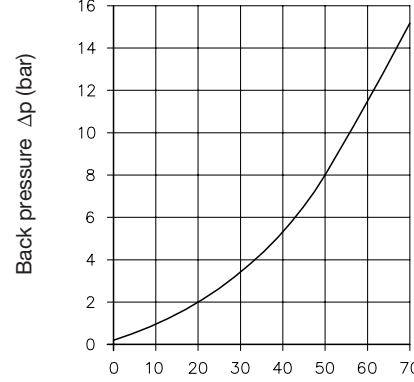
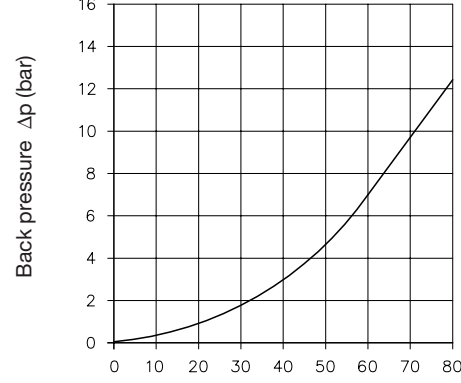
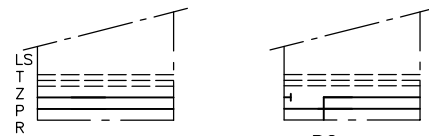
Coding	Brief description	Symbols
<p>A1 RR PVPV / 4</p> 	<p>Valves section for control of single acting consumers, e.g. lifting / lowering with industrial trucks (stackers) $Q_{max} = 80 \text{ lpm}$</p> <p>Ancillary block /3 Ports H, R: G 1/2 /4 (BSPP) Ports H, R: G 3/4 (BSPP)</p> <p>Control valve for lowering; for details see D 7490/1 PV - Prop. directional seated valve type EMP 31 V PV 70 - Prop. directional seated valve type EMP 31 V 70 PV 80 - Prop. directional seated valve type EMP 31 V 80</p> <p>Control valve for lifting; for details see D 7490/1 PV- Prop. directional seated valve type EMP 31 V PV 70 - Prop. directional seated valve type EMP 31 V 70 PV 80 - Prop. directional seated valve type EMP 31 V 80</p> 	<p>$\Delta p \text{ P} \rightarrow \text{H}$ (lifting)</p>  <p>$\Delta p \text{ H} \rightarrow \text{P}$ (lowering)</p> 
<p>ZPL 22 ZPL 22/7</p>	<p>Spacer plate (7 mm or 39.5 mm) (see note in table 1)</p>	 <p>ZPL 22 ZPL 22/7</p> <p>ZPL 2 - Z2</p>
<p>ZPL 2 - Z2</p>	<p>Intermediate plate with additional port p for a second pup circuit</p>	

4. Characteristic data

4.1 General and hydraulic

Type coding	PSL, PSV see sect. 3.1			
Design	Spool valve of block design, up to 10 spool valves, all-steel			
Mounting	Tapped holes: M8; see dimensions sect. 5++			
Installation position	Any			
Ports	P	= Pressure inlet (pump) / lead-on		
	R	= Return		
	A, B	= Consumer ports		
	U, W	= Load-signal outlet at the indiv. spool valve section		
	LS	= Load-signal outlet e.g. connection of pump metering valve at PSV		
	Attention: No pressure input!			
	M	= Pressure gauge port (pump side)		
	Z	= Pilot pressure port (20...40 bar inlet, 20 or 40 bar outlet)		
T	= Control oil return port			
Y	= Load-signal inlet port (end plate E 2, E 5, E 18, E 18 UNF, E 20 and E 20 UNF)			
Port size	P, R, A, B	= Acc. to type coding (see sect. 3.1)		
	M, LS	= G 1/4 (ISO 228/1) (BSPP) or 7/16-20 UNF-2B (SAE-4, SAE J 514)		
	U, W	= G 1/8 (ISO 228/1) (BSPP)		
	Z, T, Y	= G 1/8 (ISO 228/1) (BSPP) or 7/16-20 UNF-2B (SAE-4, SAE J 514)		
Surface coating	All surfaces corrosion-inhibiting, gas nitrided			
	Solenoid at actuation E.. and additional functions FP 1 ... FP 3, FPH 1 ... FPH 3			
	Zinc galvanized and anodized			
Mass (weight) approx.	Spring housing with actuation A, EA: Zinc die-cast			
	Connection block:	PSV 3 = 1.7 kg ¹⁾ PSL 3 = 1.7 kg ¹⁾ PSL 4 = 2.0 kg PSL 3 Z = 2.0 kg	End plates: E 1 ... E 5 = 0.5 kg E 17, E 19 (UNF) = 1.0 kg E 18, E 20 (UNF) = 1.0 kg	
	1) + 0.6 kg at version with EM 21 D(DS)	Intermediate plates: ZPL 32 = 1.2 kg ZPL 52 = 2.6 kg		
Directional spool valve:		Standard version	With additional functions A .. B .. FP(H) 1(2, 3), S 1	
	Actuation	A, E, E0A EA EHA HA	1.6 kg 1.9 kg 1.8 kg 2.2 kg	2.0 kg 2.3 kg 2.2 kg 2.5 kg
Ancillary blocks:	/ (UNF) 2	=	0.25 kg	
	/ (UNF) 2 AS.. BS.., /3	=	0.3 kg	
	/ (UNF) 2 AN.. BN..	=	0.4 kg	
	/ (UNF) 2 AL(X)-0-... BL(X)-0...	=	0.6 kg	
	/ (UNF) 2 DRH, /ZDRH	=	0.3 kg	
	/ZSS, /ZVV, /3 AVT, /3 BVT	=	1.0 kg	
	/ZDR, /ZDS, /Z 2 A(B)..	=	1.0 kg	
	/32 DFA, /32 DFB	=	0.6 kg	
	/Z 40	=	0.5 kg	
/ZAL.. BL..	=	0.6 kg		
Pressure fluid	Hydraulic fluid acc. to DIN 51524 table 1 to 3; ISO VG 10 to 68 acc. to DIN 51519			
	Viscosity range: min. approx. 4 mm ² /sec; max. approx. 1500 mm ² /sec			
	Optimal operation range: approx. 10 ... 500 mm ² /sec			
	Also suitable are biologically degradable pressure fluids of the type HEPG (Polyalkylenglycol) and HEES (synth. Ester) at operation temperatures up to approx. +70°C. HETG (e.g. rape seed oil) or water based fluids e.g. HFA or HFC must not be used!			
Temperature	Ambient: approx. -40 ... +80°C;			
	Oil: -25 ... +80°C, pay attention to the viscosity range!			
	Start temperature down to -40°C are allowable (Pay attention to the viscosity range during start!), as long as the operation temperature during consequent running is at least 20K higher. Biological degradable pressure fluids: Pay attention to manufacturer's information. With regard to the compatibility with sealing materials do not exceed +70°C.			
Rec. contamination class	ISO 4406 20/18/15			
Operating pressure	p _{max} = 420 bar; Ports P, A, B, LS, M, Y, U, W, p _{min} = 50 bar			
	The max. pressure achievable at the consumer side of the spool valves is lowered by the amount equivalent internal control pressure drop at the 3-way flow regulator of the PSL (see curves "Connection block PSL" on next page) or at the pump flow regulator (PSV). Return port R(R1) ≤ 50 bar; port T pressureless with separate pipe (e.g. 8x1) to the tank, port Z approx. 20 or 40 bar (acc. to coding, see table 8) (outlet); ≤ 40 bar (inlet)			
Control circuit	For control pressure, see Q-I-characteristics. The internal control oil circuit is by means of a disk filter sufficiently protected against malfunctions caused by contamination.			
Flow	Max. consumer flow acc. to table 15 sect. 3.2.1			

4.2 Curves

Oil viscosity during measurement approx. 60 mm²/sec

Pressure limiting valve in the connection block

Type PSL 3../D../-2
PSL UNF 2../D../-2
PSV 3../D../-2
PSV UNF 2../D../-2
PSV 4 N...

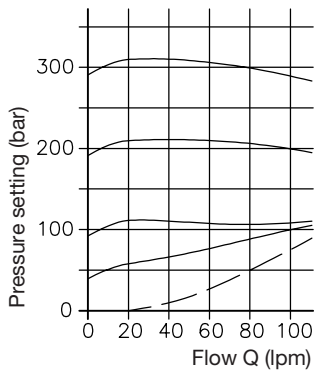

Type PSL 3 U../-2
PSL UNF 2 U../-2

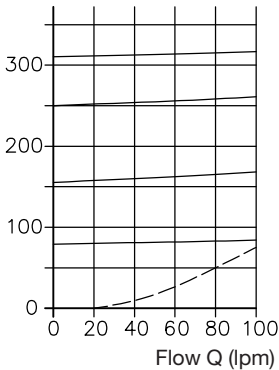

Prop. pressure limitation in the connection block

Type PSL (PSV) ..V (Z,ZM)

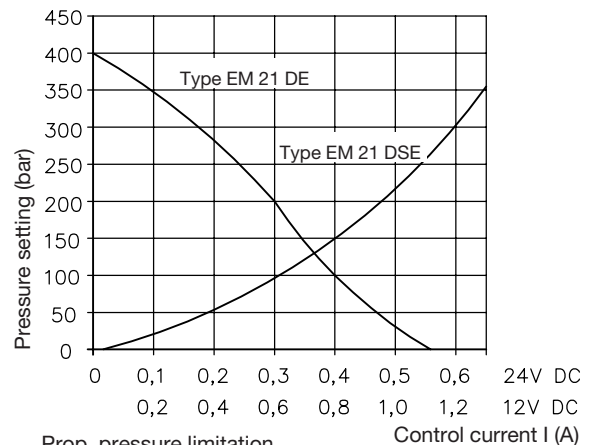

Connection block type PSL...
Circulation pressure P → R

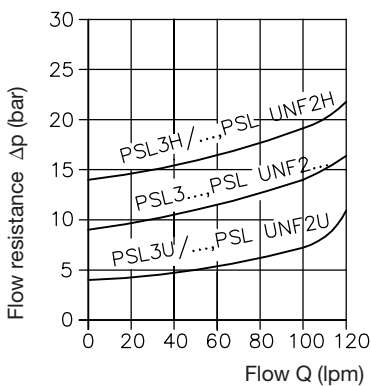

Directional spool valve
P → A(B), A(B) → R

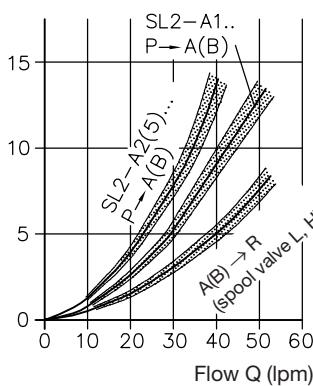

Prop. pressure limitation

Coding A.. B.. acc. to table 17, sect. 3.2.1

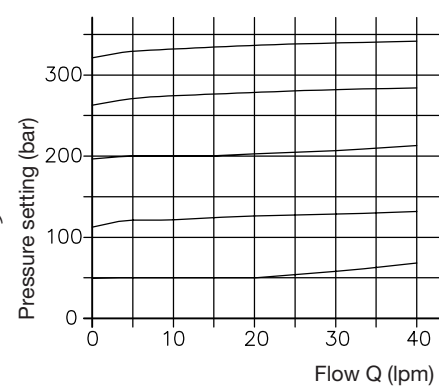

2-way inflow controllers

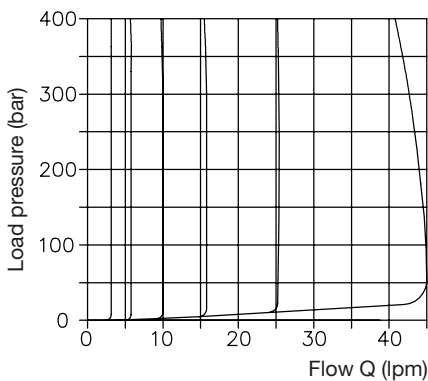

Prop. pressure limitation

Coding FP(H) 1, (FP(H) 2, FP(H) 3, table 17, sect. 3.2.1

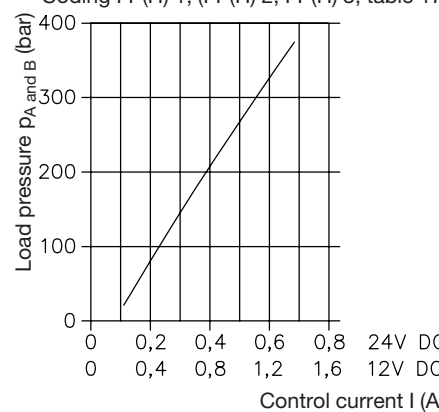

Control curve for consumer flow

(Guide line, example for directional spool valve type SL 2-..2../- with inflow controller)

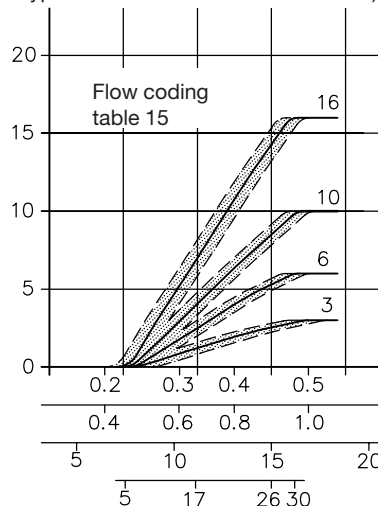
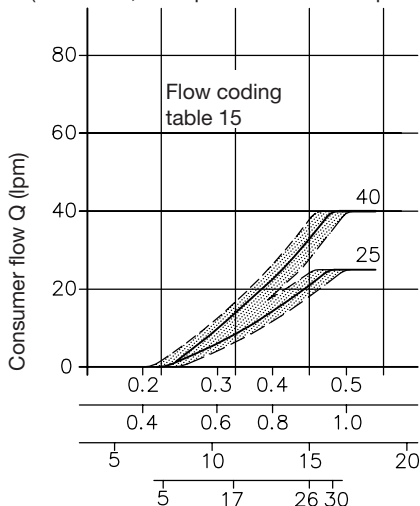

- ← Control current I (A) 24V DC
- ← Control current I (A) 12V DC
- ← Control pressure (bar) hydraulic actuation HA
- ← Angle (°) at hand lever, manual actuation A

4.3 Actuators

For other data such as coding, symbols etc., see sect. 3.2

Actuation E0A

	Actuating moment (Nm)	
	Idle position	End position
Version E0A	approx. 1.3	approx. 1.7
Version EHA, HA	approx. 1.7	approx. 3.3
Version EA	approx. 1.3	approx. 2.5

Actuation E0C

Version with detent, fixation of the valve spools at any desired position (idle position with special notch)

AR, ER, EAR

Version with detent, fixation of the valve spool at idle and both end positions
Required pulse duration for switching: approx. 1 sec

Actuation E, EA, EHA

Prop.-Solenoid, manufactured and tested acc. to DIN VDE 0580

Twin solenoid with anchor chambers sealed on the outside and connected to the return duct, the anchors are thereby maintenance-free lubricated and protected against corrosion by the hydraulic fluid.

See also:

Notes at Sk 7814 as well as for optional components sect. 6.1 i !

Rated voltage U_N	24V DC	12V DC
Coil resistance R_{20}	28 Ω	6.7 Ω
Current, cold I_{20}	0.86 A	1.8 A
Lim. current $I_G (I_{lim})$	0.58 A	1.16 A
Power, cold $P_{20} = U_N \times I_{20}$	21 W	22 W
Lim. power $P_G = U_N \times I_G$	13.9 W	13.9 W
Cut-off energy W_A	≤ 0.3 Ws	≤ 0.3 Ws
Rel. duty cycle	S 1	S 1
(reference temp. $\vartheta_{11} = 50^\circ\text{C}$)		
Required dither frequency		40...70 Hz (best. 55 Hz)
Ditheramplitude ¹⁾	$20\% \leq A_D \leq 50\%$	

I - stroke- curve

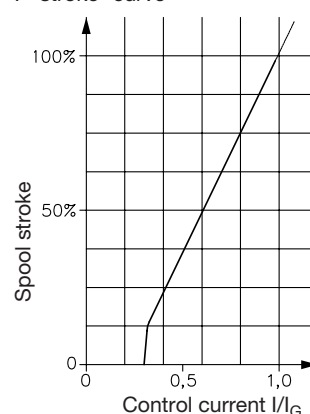

$$1) A_D (\%) = \frac{I_{\text{peak-peak}}}{I_G} \cdot 100$$

Oil viscosity during measurement approx. 60 mm²/sec

Electr. connection

Circuitry for coding -G 12(24)
-X 12(24)

3-pin
DIN EN 175 301-803 A
IP 65 (IEC 60529)
(standard version)

3-pin
Coil a Coil b

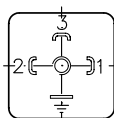
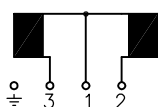

Circuitry for coding -S 12(24)

3-pin
IP 67 (IEC 60529)

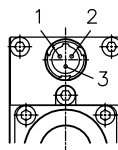

Circuitry for coding -DT 12
-DT 24

4-pin
IP 69 K (IEC 60529)

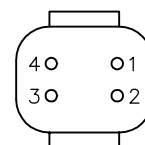

Circuitry for coding -AMP 12(24) K 4
AMP Junior Timer,
4-pin
IP 67 (IEC 60529)

4-pin
Coil a Coil b

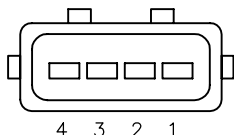
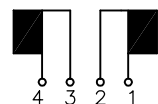

Circuitry for coding ..-G 24 C 4

4-pin
DIN EN 175 301-803 C
IP 65 (IEC 60529)

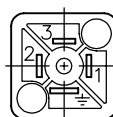

3 1 2 4 (with coding ...C 4)

The IP-specification only applies when the plug is mounted as specified.

Actuation EHA, HA

Control pressure approx. 5 bar (start of stroke)
approx. 18 bar (full elevation)

The remote control lines to the control port 1 and 2 have to be piped externally. Supply is via proportional piloting valve e.g. type FB 2/18 etc. or KFB 2/18 (both acc. to D 6600).

Actuation suffix VCHO, VCHC

The idle position of the valve spool is monitored by a contact switch from Co. BURGESS, type V 4 N 4 Sk 2 ® with lever AR 1

Switch compressed at idle position

Electrical connection

via plug, e.g. type G 4 W 1 F ® Co. HIRSCHMANN, www.hirschmann.com

Protection class

IP 65 (IEC 60529)

Circuit-breaking capacity

= 5 A

up to 30V DC

= 3 A

Inductive load

Circuitry

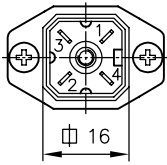

VCHO

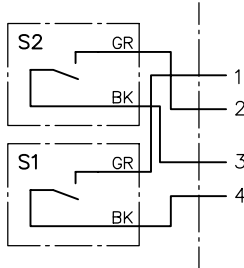

VCHC

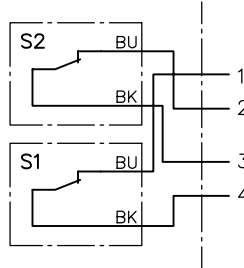

Switch function
S 1 - direction A
S 2 - direction B

Actuation suffix WA

Position sensor supervision of the valve spool stroke via a Hall-sensor

Circuitry

Coding G

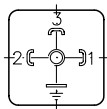

2 = +U_B operating voltage (5 up to 10 V)
1 = U_{output}
3 = GND

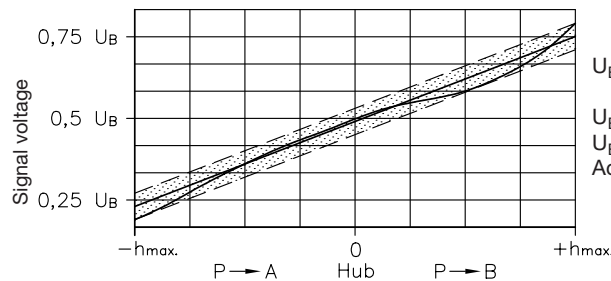

U_B = Supply voltage
U_{B max} = 76%
U_{B min} = 24%
Accuracy ± 9% (of U_B)

Coding AMP...

Coding S..

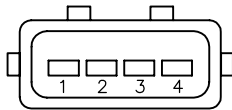

The DC supply voltage must be stabilized and smoothened.

Attention: Any strong magnetic field will destroy the sensor!

Actuation suffix WA

Electr. connection acc. to the coding, see table 3

Actuation suffix U

Comparator (stroke monitoring / side indication)

Coding G

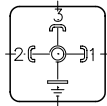

Pin	Signal	Description
1	OUT _A	PNP-transistor (switched on high-side)
2	OUT _B	PNP-transistor (switched on high-side)
3	+U _B	10 ... 32V DC
4/GND	GND	0V DC

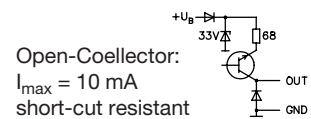

Open-Collector:
I_{max} = 10 mA
short-cut resistant

Residual ripple ≤ 10%

Coding AMP...

Electr. connection acc. to the coding, see table 3

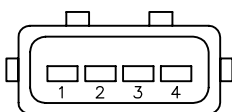

Signal table			
Ident. No.	Spool movement	OUT _A	OUT _B
1	Idle position middle	ON	ON
2	P → B	OFF	ON
3	P → A	ON	OFF

4.4 Prop. pressure limitation and functional cut-off

Functional cut-off	Prop. solenoid with manual emergency actuation	
Prop. pressure limitation	Rated voltage U_N	24V DC 12V DC
	Coil resistance R_{20}	28 Ω 6.7 Ω
	Current, cold I_{20}	0.86 A 1.8 A
	Lim. current I_G (I_{lim})	0.58 A 1.16 A
	Power, cold $P_{20} = U_N \times I_{20}$	21 W 22 W
	Max. power $P_G = U_N \times I_G$	13.9 W 13.9 W
	Cut-off energy W_A	≤ 0.3 Ws ≤ 0.3 Ws
	Rel. duty cycle ¹⁾	S 1 S 1
	(reference temp. $\vartheta_{11} = 50^\circ\text{C}$)	
	Required dither frequency	40...70 Hz (best. 55 Hz)
	Dither amplitude	$20\% \leq A_D \leq 35\%$
	Electr. connection	DIN EN 175 301-803 A
	Protection class (assembled)	IP 65 (IEC 60529)
	Circuit	Coil b Coil a

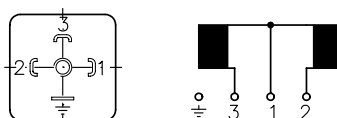
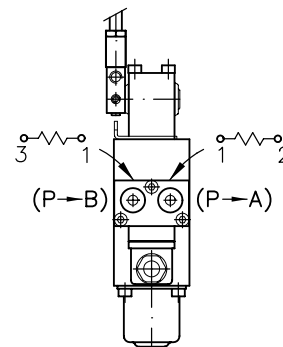

¹⁾ **Note:** The duty cycle applies only when not both coils are actuated simultaneously. The perm. duty cycle is only 50% when both coils are energized simultaneously.

4.5 Other solenoid valves

Electrical data	- Connection blocks coding Z, ZM, V - Intermediate plates coding /ZSS, /ZVV, /ZVX, /ZXV		- Intermediate plate coding -A 1 RR PV.PV		- Ancillary blocks coding /3 AVT, /3 BVT - Intermediate plates coding /ZDR, /ZDS, /Z 2 A., /Z 2 B..	
Additional documentation	D 7490/1, D 7490/1 E (type EM)		D 7490/1 (type EMP 3)		D 7765 (type BVG 1)	
Nom. voltage U_N	24V DC	12V DC	24V DC	12V DC	24V DC	12V DC
Nom. power P_N	21 W	21 W	30 W	30 W	27.6 W	29.4 W
Nom. current I_N	0.63 A	1.2 A	1.25 A	2.5 A	1.15 A	2.4 A

Electr. connection

Circuitry with codings -G 12, -G 24
-X 12, -X 24
DIN EN 175 301-803 A
IP 65 (IEC 60529)

Circuitry with codings -S 24
Plug Co. SCHLEMMER
Type SL-10
IP 67 (IEC 60529)

Circuitry with codings -AMP 24
Plug AMP Junior Timer
2-pin
IP 65 (IEC 60529)

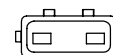
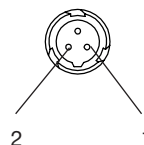
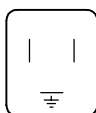

Type PSL 3 Z

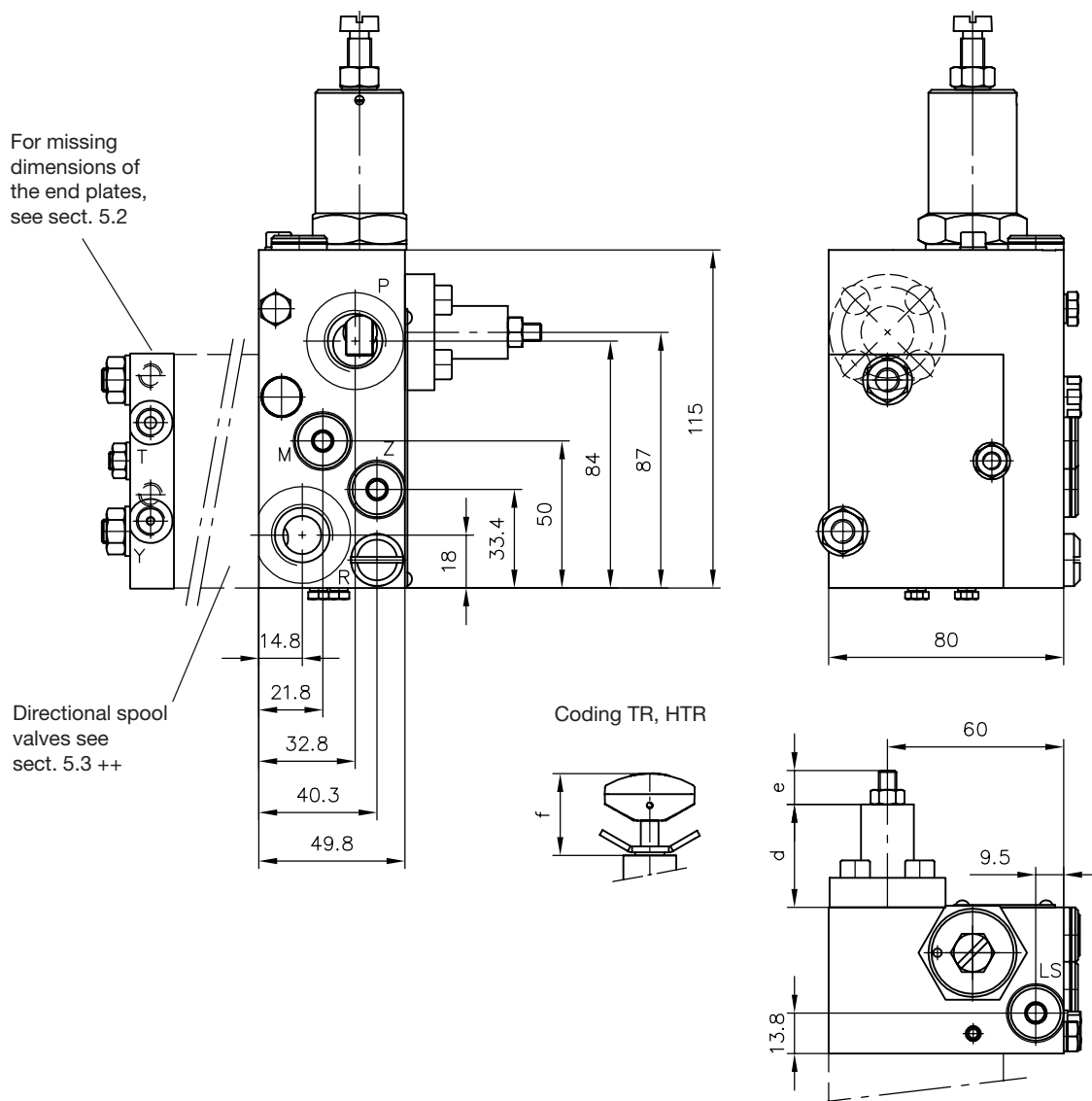

Ports conf. ISO 228/1 (BSPP) or SAE J 514:

Type	P and R	LS, M and Z
PSL 3 Z ...-2	G 1/2	G 1/4

	d
PSL 3 Z	22
PSL 3 Z T (TR)	35
PSL 3 Z H	40
PSL 3 Z HT (HTR)	53

e ≈ 8 with PSV (blocked controller)
 > 11 with PSL

f ≈ 28 with PSV (blocked controller)
 > 31 with PSL

Type PSL 3 U
PSL UNF 2 U

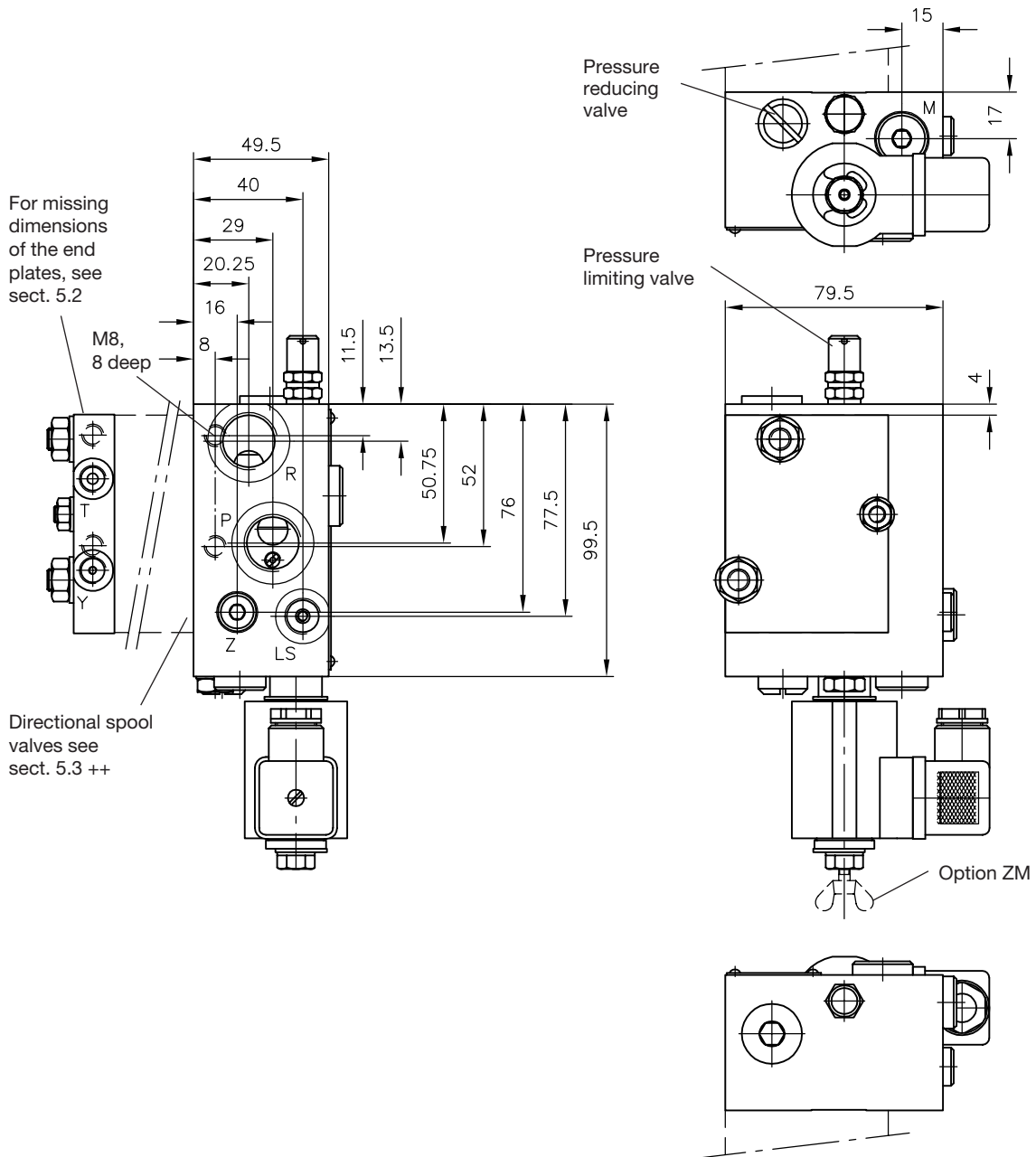

Ports conf. ISO 228/1 (BSPP) or SAE J 514:

Type	P and R	LS and M	Z
PSL 3 U ../..-2	G 1/2	G 1/4	G 1/8
PSL UNF 2 U ../..-2	3/4-16 UNF-2B	7/16-20 UNF-2B	7/16-20 UNF-2B

Type PSV 4 N

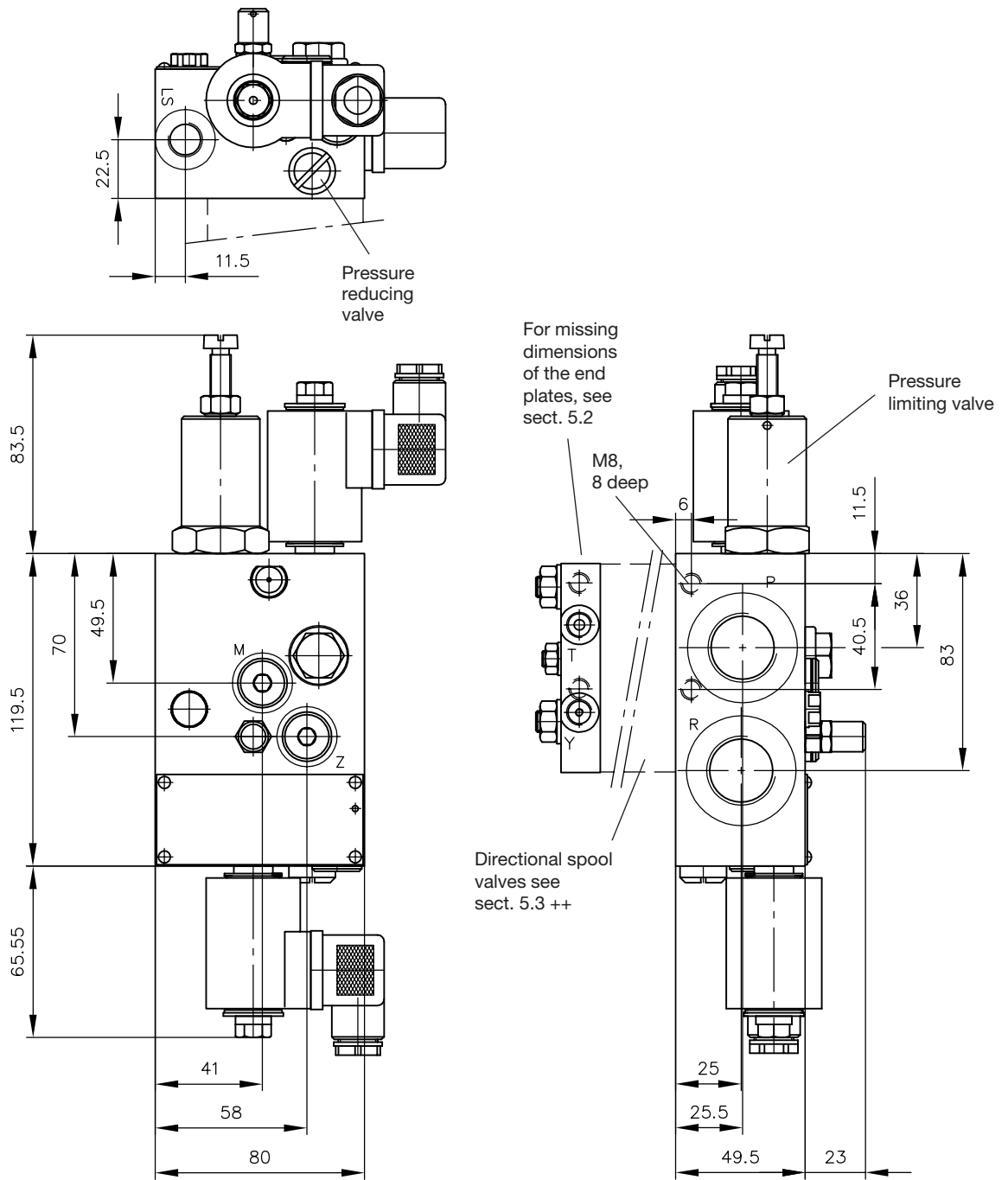

Ports:

Type	P and R	LS and M	Z	
PSL 4 N	G 3/4	G 1/4	G 1/8	ISO 228/1 (BSPP)
PSL UNF 4 N	11/16-12 UN-2B (SAE-12)	7/16-20 UNF-2B (SAE-4)	7/16-20 UNF-2B (SAE-4)	SAE J 514

Adapter plates type ZPL 32 and ZPL 52 (see also D 7700-3 and D 7700-5)

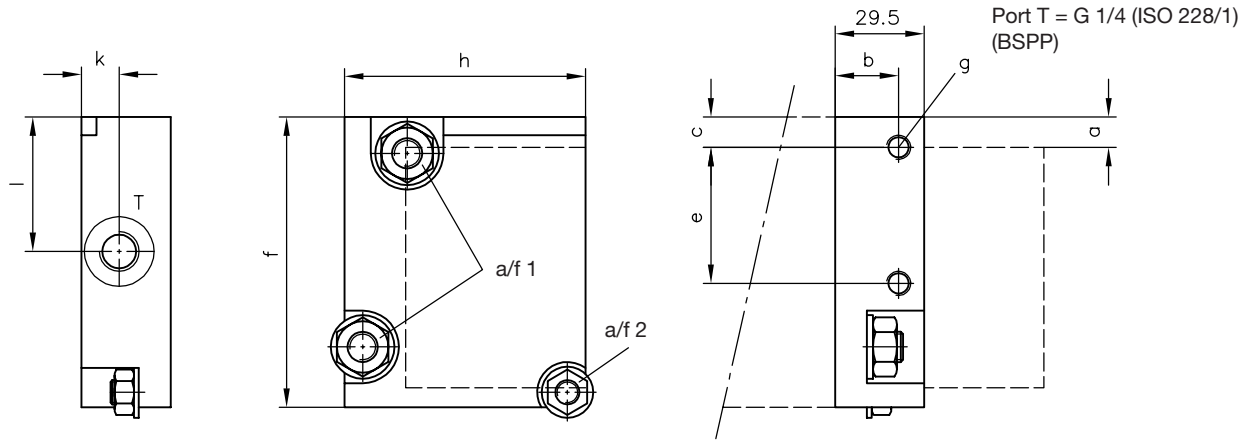

Type	a	b	c	e	f	g	h	k	l	a/f 1	a/f 2
ZPL 32	10	16	10	45	96	M8, 10 deep	79.7	17	21	17, 46 Nm	13, 23 Nm
ZPL 52	12	14.75	30	40	119.5	M10, 10 deep	100	12	37.8	19, 60 Nm	19, 60 Nm

5.2 End plates

Type E 1, E 2, E 4 and E 5

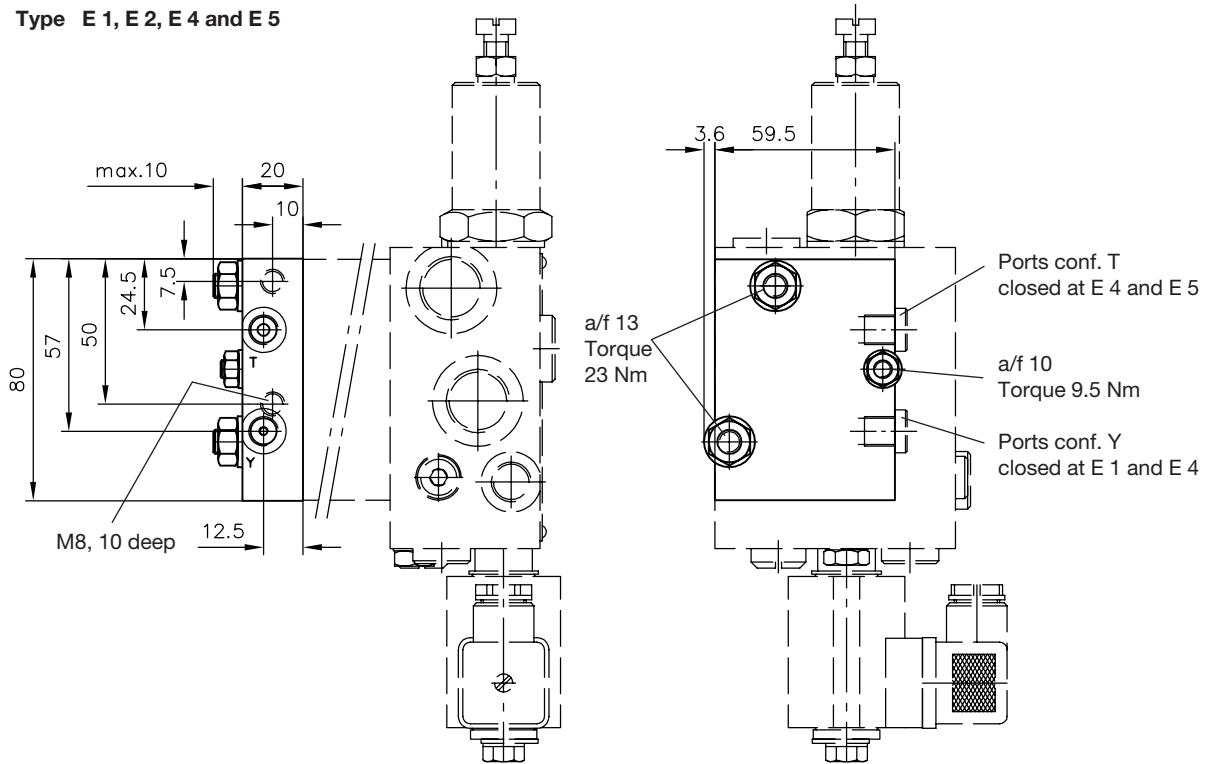

Type E 17 ... E 20
E 17 UNF ... E 20 UNF

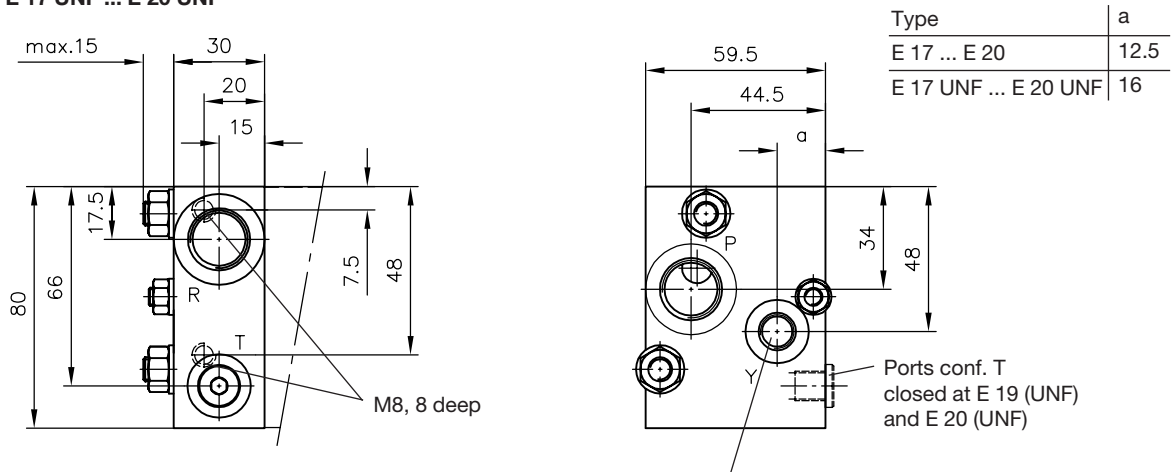

Ports conf. ISO 228/1 (BSPP):
T and Y = G 1/8
P and R = G 3/8

Ports conf. SAE J 514 (E.. UNF):
T and Y = 7/16-20 UNF-2B (SAE-4)
P and R = 3/4-16 UNF-2B (SAE-8)

Ports conf. Y
closed at E 17 (UNF)
and E 19 (UNF)

5.3 Directional spool valves with manual actuation type E0A, E0C and E0AR

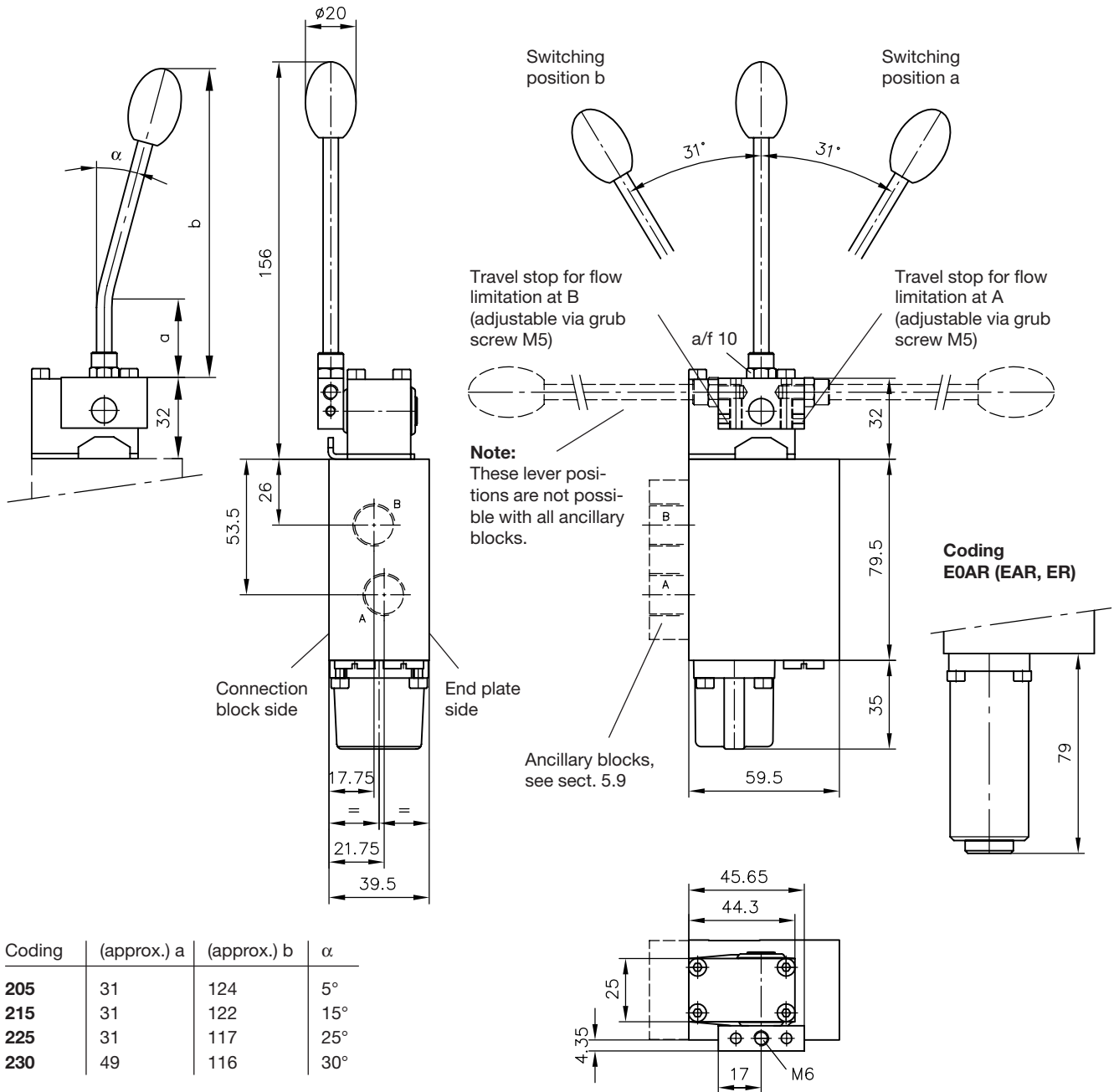

The travel stops as flow limitation at A and B allow the consumer flow Q_{max} of the utilized spool to be smoothly reduced to intermediate values down to Q_{max} of the spool with the next smaller flow coding (table 15, sect. 3.2.1).

5.4 Spool valves with actuation type E and EA

Actuation type EA, E0A

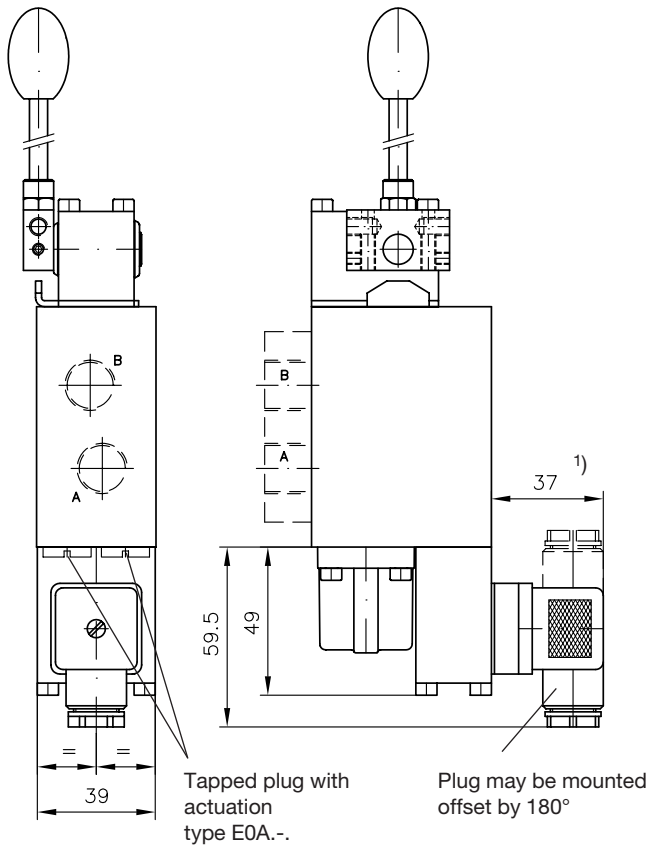

Actuation type E

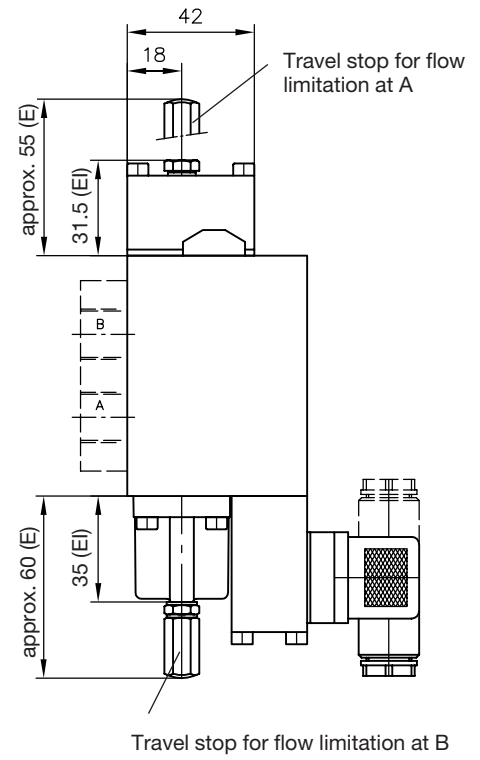

1) This dimension (plug) depends on the make and may be up to 50 mm acc. DIN EN 175 301-803 A

Additional solenoid versions

Coding -S 12
-S 24

Coding -AMP 12 K 4
-AMP 24 K 4

Coding -DT 12
-DT 24

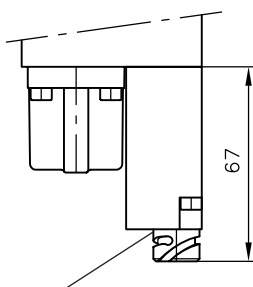

Manual emergency actuation

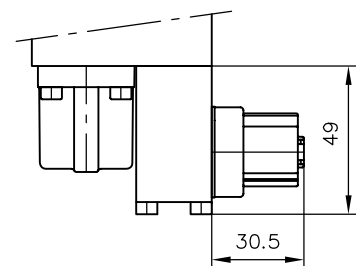
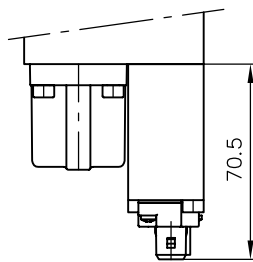

Coding -G(X) 12 T
-G(X) 24 T

Coding -G(X) 24 C 4

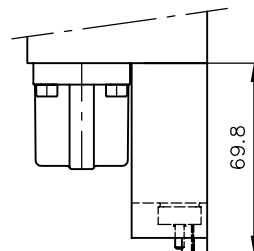
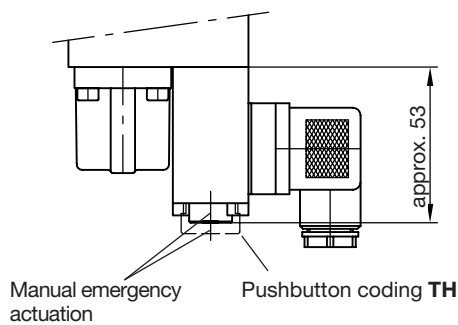

5.5 Spool valves with actuation type E0HA and EHA

Actuation type **E0HA**

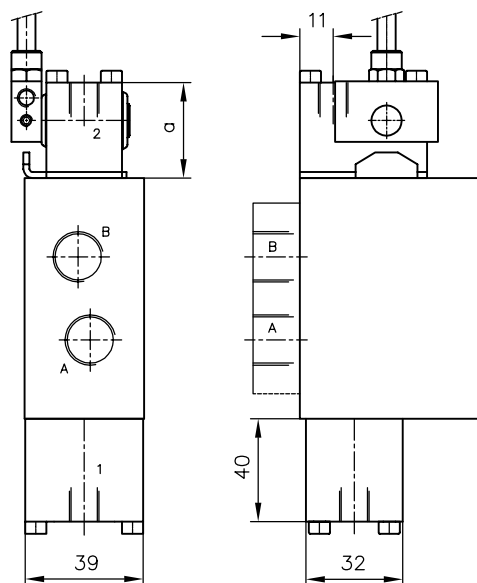

Actuation type **EHA**

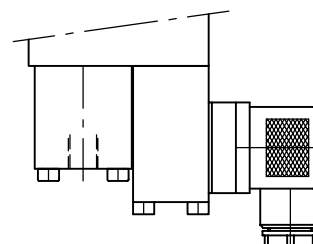

Ports conf. ISO 228/1 (BSPP):

a = 34.5
1, 2 = G 1/8

Ports conf. SAE J 514:

a = 39.5
1, 2 = 5/16-24 UNF-2B

5.6 Spool valves with actuation type K

Actuation type **K**

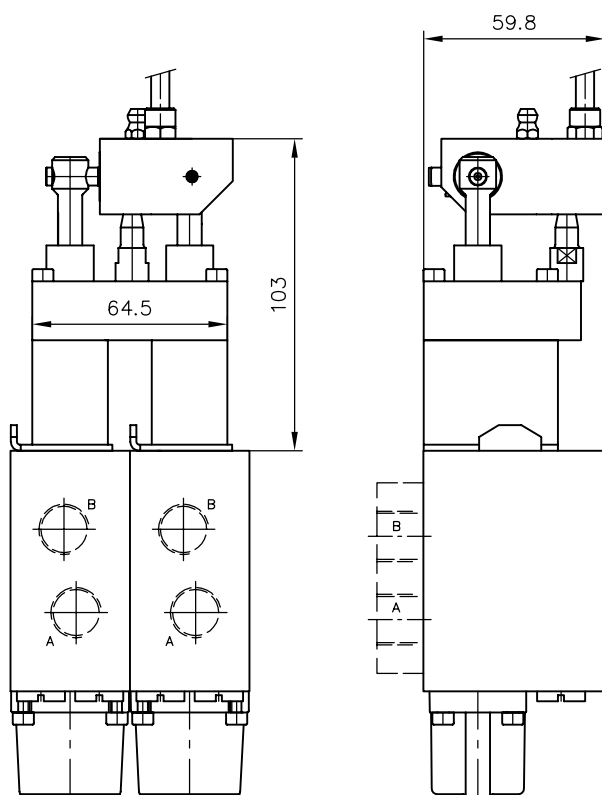

5.7 Lift monitoring

Type **..WA, ..U**

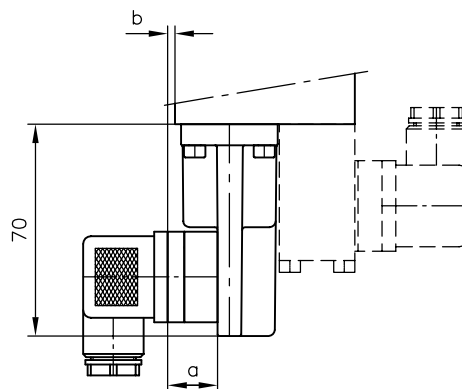

	a	b
U	31	17
WA	17	4.4

Type **..VCHO, ..VCHC**

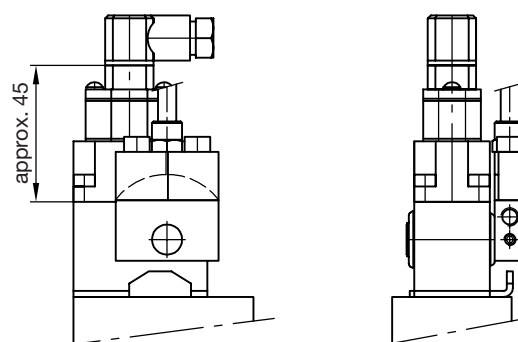

5.8 Spool valves with LS-pressure limitation, functional cut-off and prop. pressure limitation

Type B...

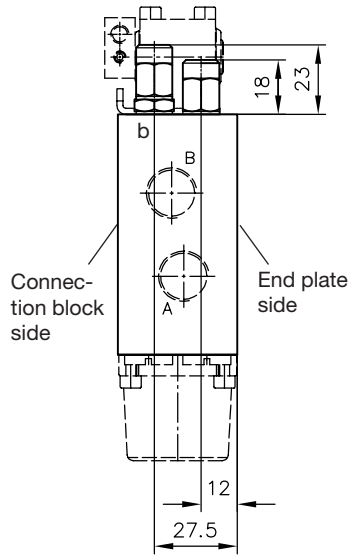

Type A...

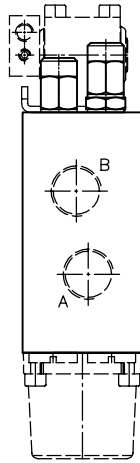

Type A...B...

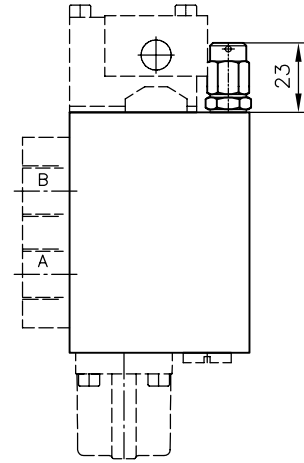
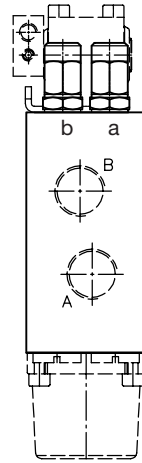

Type A...B...S 1...

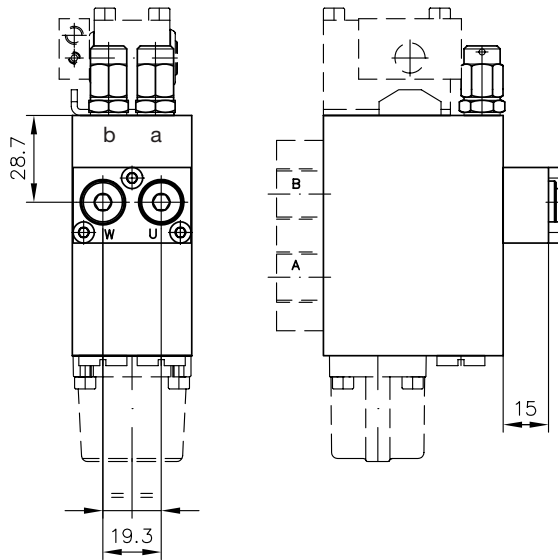

Ports conf. ISO 228/1 (BSPP):
U and W = G 1/8

For missing data (directional spool valves and actuation)
see sect. 5.3 to 5.6!

Type A...B...FP 1(2, 3)
A...B...FPH 1(2, 3)

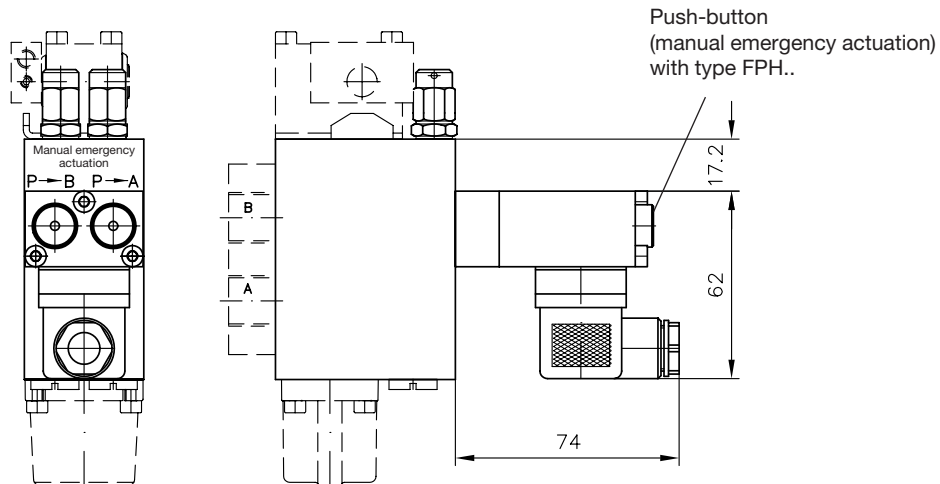

5.9 Ancillary blocks

Type /2, 3

- /UNF 2
- /22
- /2 M
- /UNF 2 M

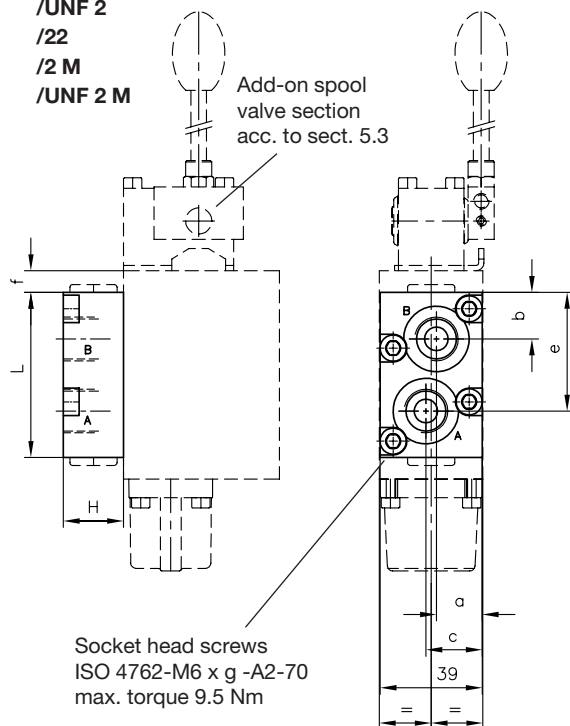

	H	L	a	b	c	e	f	g
/2 AS.. BS.. /UNF 2 AS.. BS..	39.5	83	17.5	27.75	21.5	55.25	1.75	40
/22 AS.. BS..	39	105	20.2	22.5	19.5	83.5	1.75	39
/2 AN.. BN.. /UNF 2 AN.. BN..	39.5	103	17.5	37.75	21.5	65.25	11.75	40
/22 AN.. BN..	44.5	120	19.5	14	21	83.5	28.75	45
/2 DRH /UNF 2 DRH	45.5	89	22 21.5	13 15.5	18 17.5	76 73.5	4.75	46
/2	15.5	63	17.5	17.75	21.5	45.25	8.25	16
/22	24.5	68	21	13	18	55	6.25	25
/UNF 2	16	63	17.5	17.75	21.5	45.25	8.25	16
/2 M, /UNF 2 M	28	80	17.5	26.25	21.5	53.75	--	28
/3	28	80	17.5	28.5	17.5	65	8.25	28

Type /2 AS.. BS..

- /22 AS.. BS.. 2)
- /2 AN.. BN..
- /22 AN.. BN.. 2)
- /2 DRH
- /UNF 2 AS.. BS..
- /UNF 2 AN.. BN..
- /UNF 2 AN..
- /UNF 2 BN..
- /UNF 2 DRH 2)

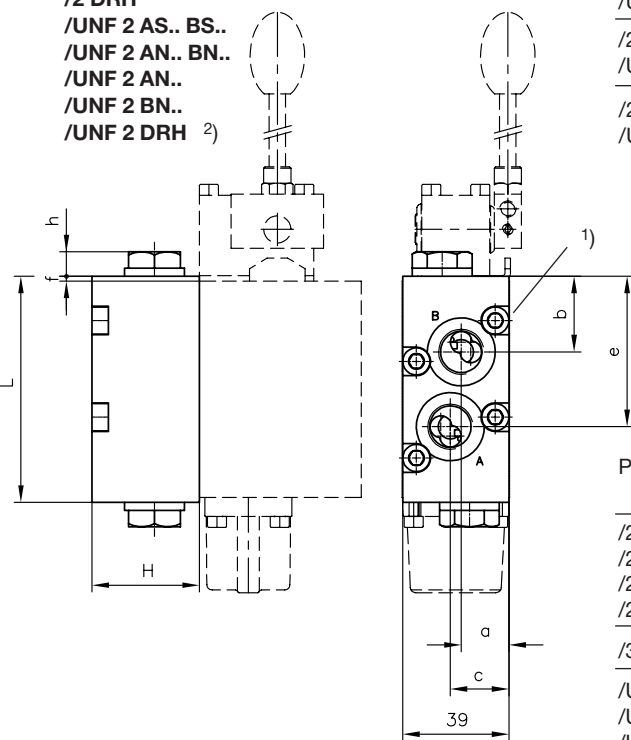

	h
/2 AS.. BS.. /UNF 2 AS.. BS..	9
/2 AN.. BN.. /UNF 2 AN.. BN..	9
/2 DRH /UNF 2 DRH	10

Ports A and B (all versions):

	ISO 228/1	SAE J 514 (SAE-8)
/2, /22 /2 AS.. BS.., /22 AS.. BS.. /2 AN.. BN.., /22 AN.. BN /2 DRH	G 3/8	---
/3	G 1/2	---
/UNF 2.. /UNF 2 AS.. BS.. /UNF 2 AN.. BN.. /UNF 2 AN.. /UNF 2 BN.. /UNF 2 DRH	---	3/4-16 UNF-2B

1) Socket head screws
ISO 4762-M6x40-A2-70 max. torque 9.5 Nm

2) **Note:** Not all lever positions are possible.

Type /2 AL(X)-0-... BL(X)-0-...
/UNF 2 AL(X)-0-... BL(X)-0-... ²⁾

Pressure adjustment
with type /... 2 AL... BL...

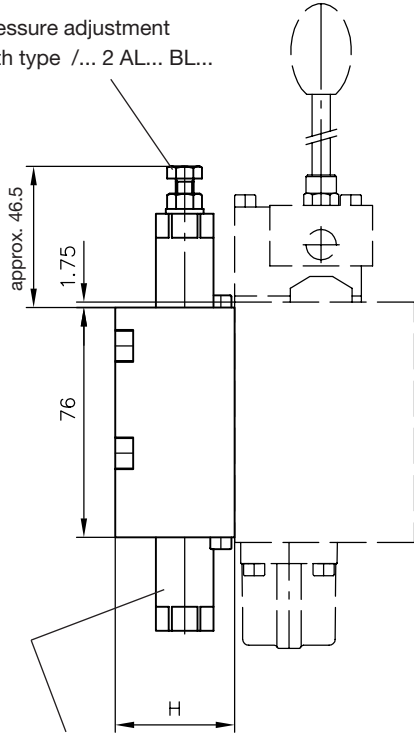

Pressure adjustment (via shims)
with type /... 2 ALX... BLX...

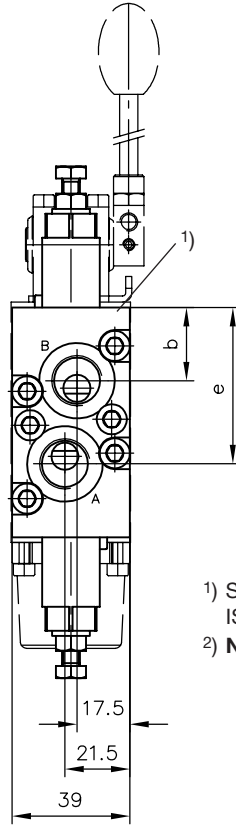

- 1) Socket head screws
ISO 4762-M6x40-A2-70 max. torque 9.5 Nm
- 2) **Note:** Not all lever positions are possible.

Ports A and B (all versions):

	ISO 228/1	SAE J 514 (SAE-8)
/2 AL(X)-0-... BL(X)-0-...	G 3/8 (BSPP)	---
/UNF 2 AL(X)-0-... BL(X)-0-...	---	3/4-16 UNF-2B

Type /2 AL(X)-0-...-

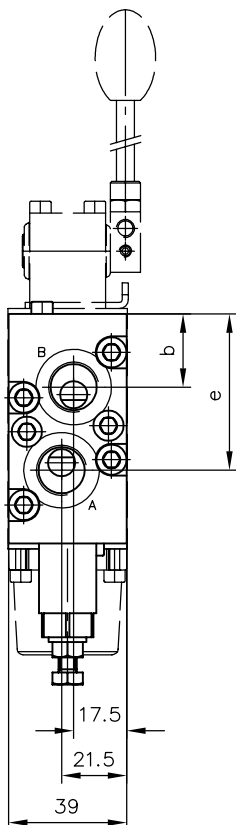
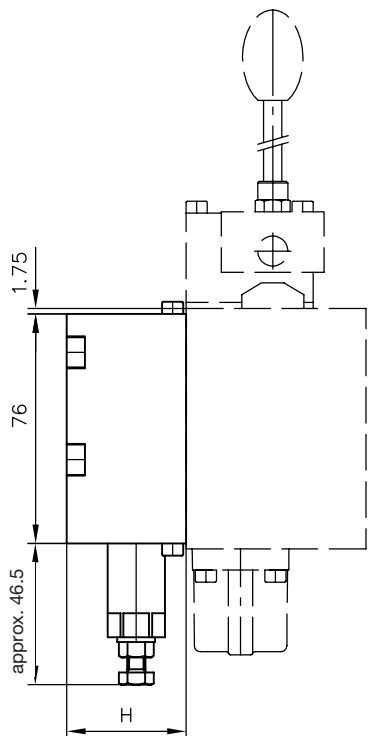

	H	b	e
/2 AL...BL...	39.5	24.25	51.75
/UNF 2 AL...BL...	44.5	23.5	52.5

Type /2 BL(X)-0-...

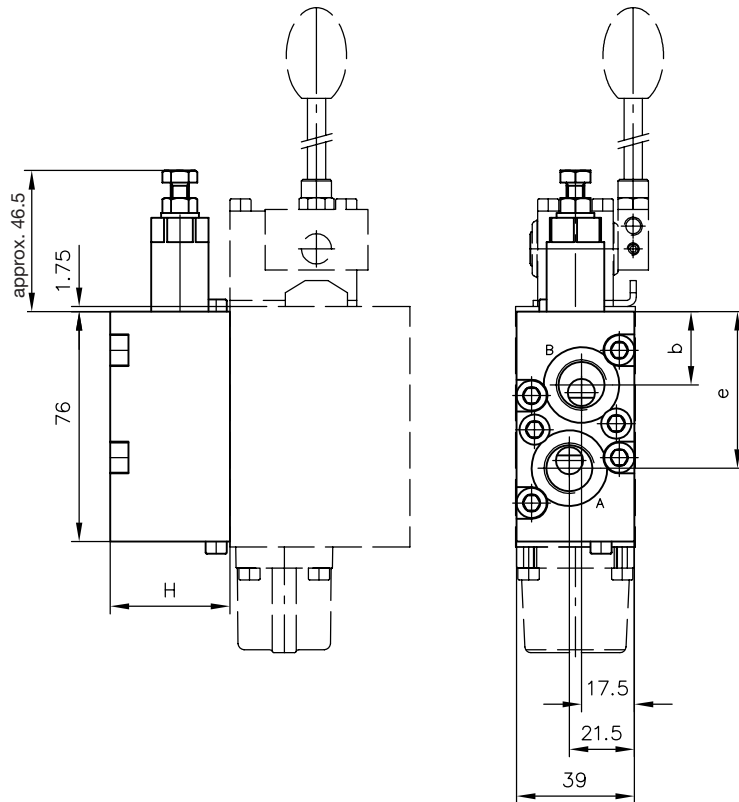

Ports A and B (all versions):

	ISO 228/1	SAE J 514 (SAE-8)
/2 AL(X)-0-... BL(X)-0...	G 3/8 (BSPP)	---
/UNF 2 AL(X)-0-... BL(X)-0...	---	3/4-16 UNF-2B

	H	b	e
/2 AL...BL...	39.5	24.25	51.75
/UNF 2 AL...BL...	44.5	23.5	52.5

Type /32 DFA 1)

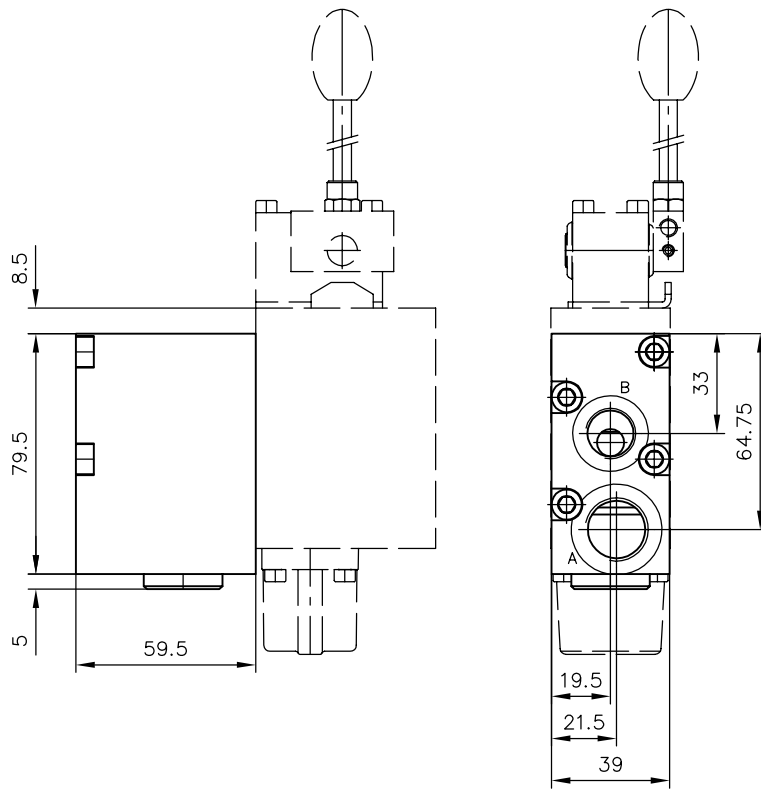

Ports A and B (all versions):
conf. (ISO 228/1) (BSPP):

- A = G 1/2
- B = G 3/8

1) **Note:** Not all lever positions are possible.

Type /32 DFB 1)

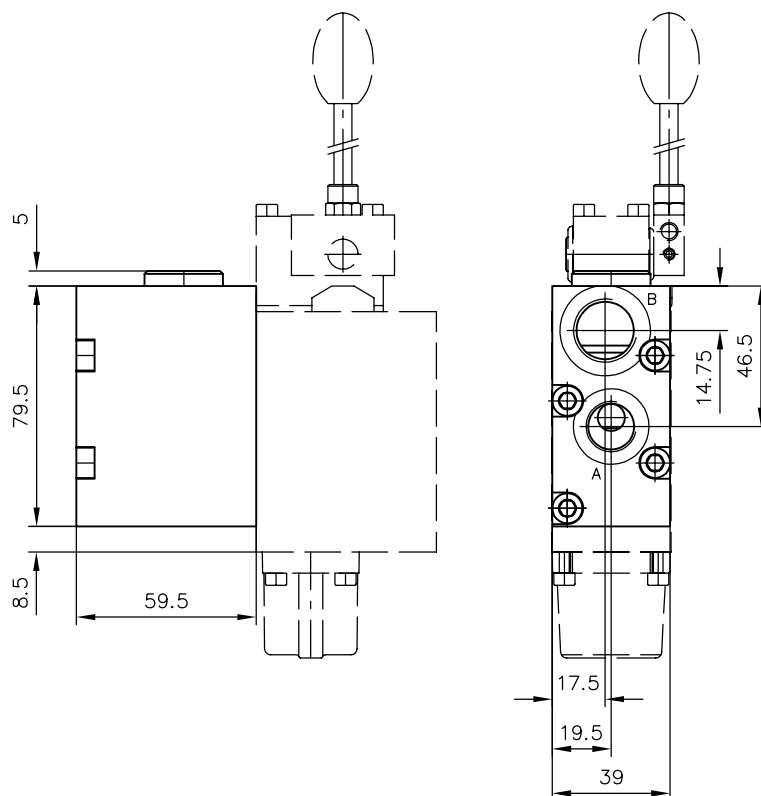

Ports A and B (all versions):
conf. (ISO 228/1) (BSPP):

- A = G 3/8
- B = G 1/2

Type /3 AVT 1)

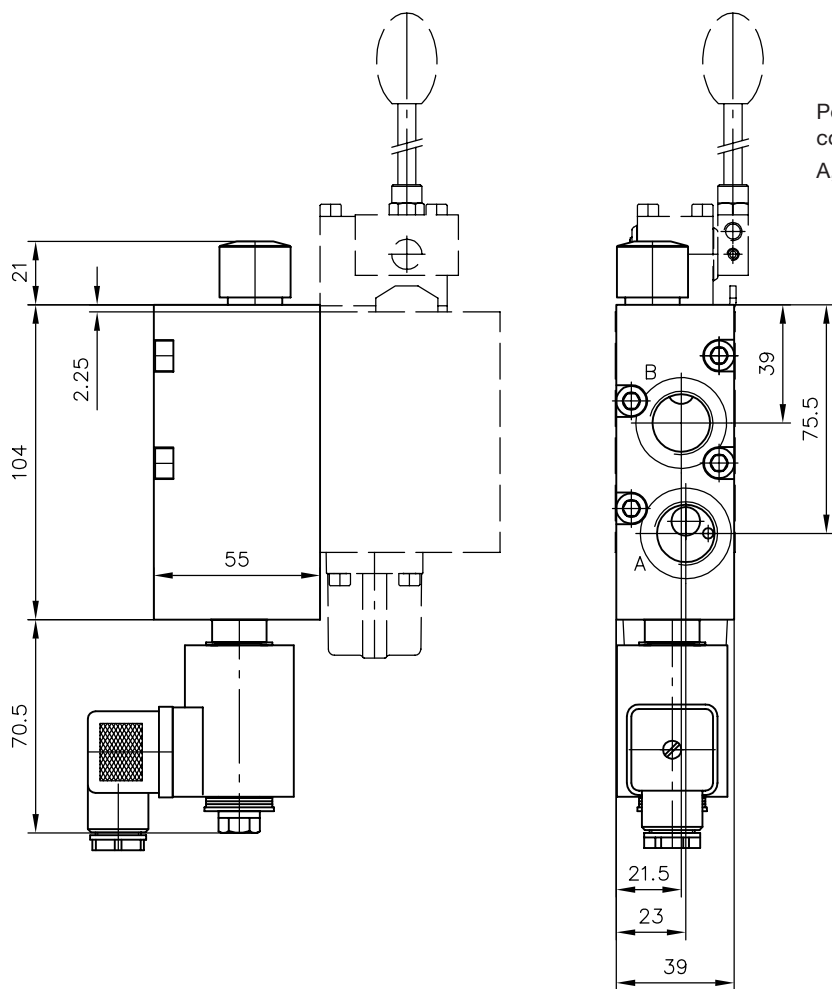

Ports A and B (all versions):
conf. (ISO 228/1) (BSPP):
A, B = G 1/2

Type /3 BVT 1)

1) **Note:** Not all lever positions are possible.

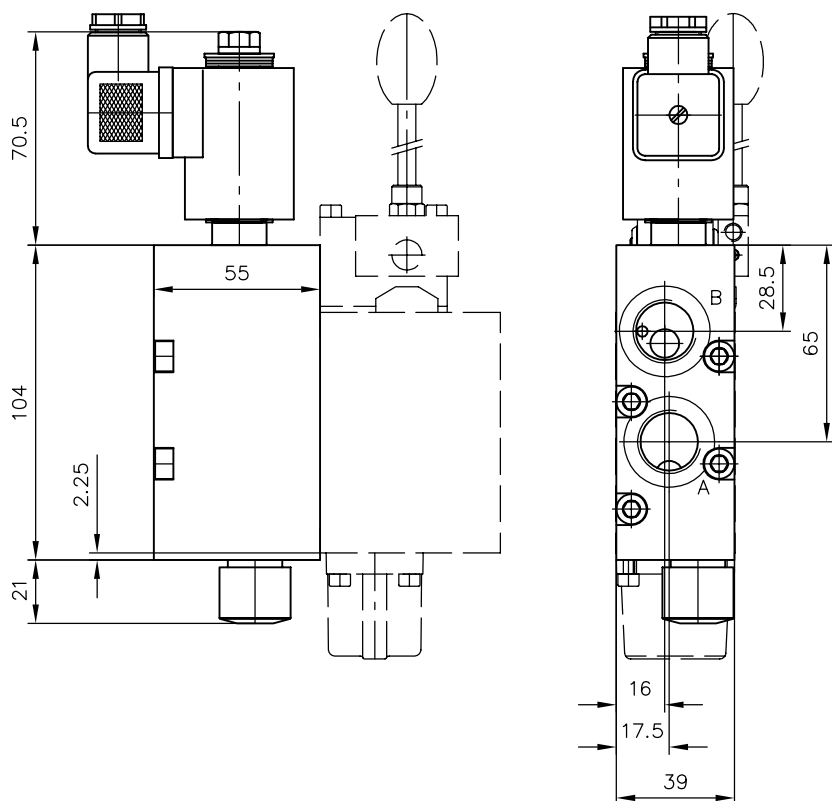

Type /2 AHN

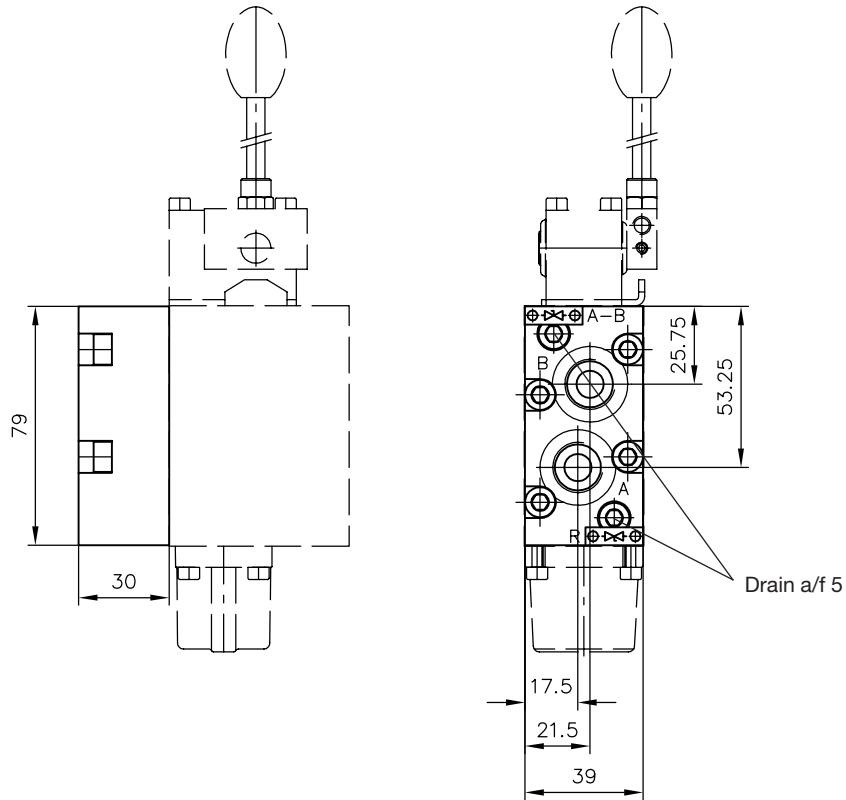

Ports A and B (all versions):
conf. (ISO 228/1) (BSPP):
A, B = G 1/2

Type /2 BHN

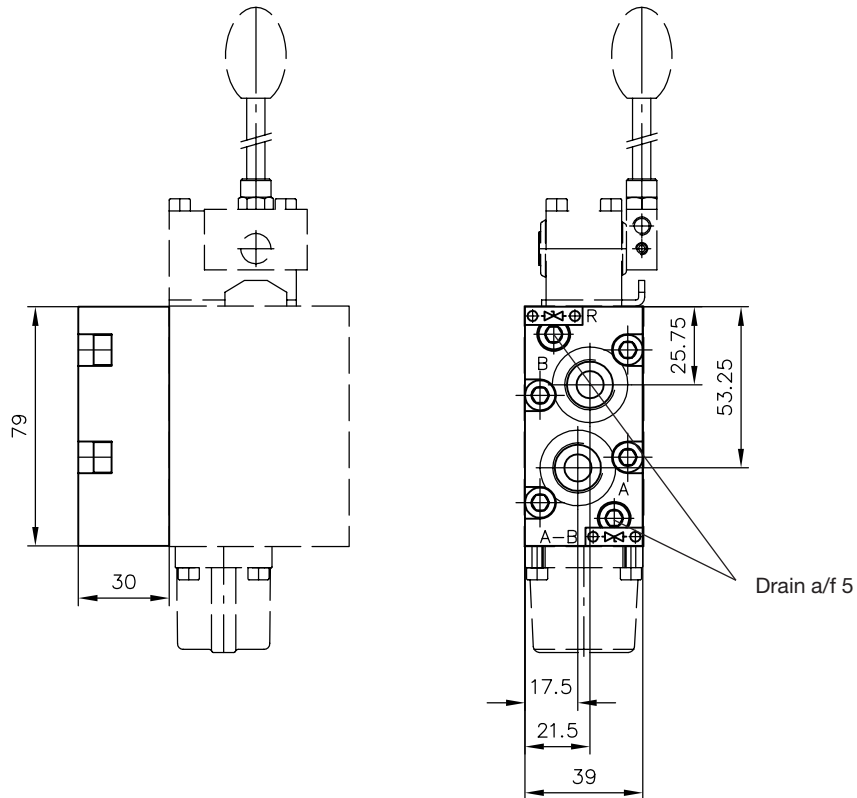

5.10 Intermediate plates for parallel connection

Type /Z 40 ¹⁾

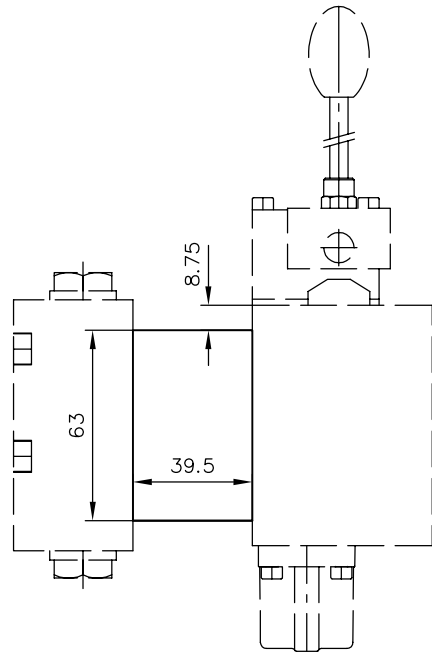

Type /ZSS, /ZVW ¹⁾

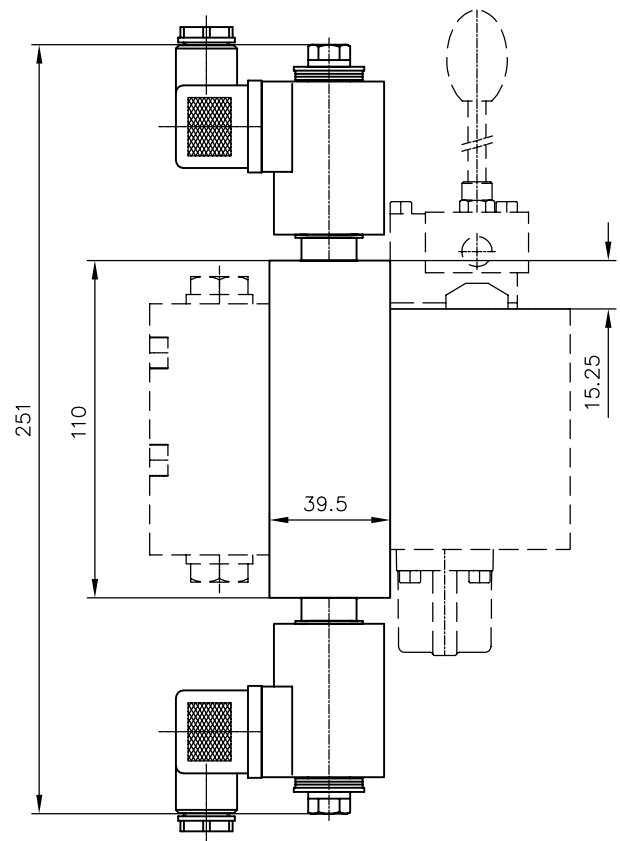

¹⁾ **Note:** Not all lever positions are possible.

Type /ZVX

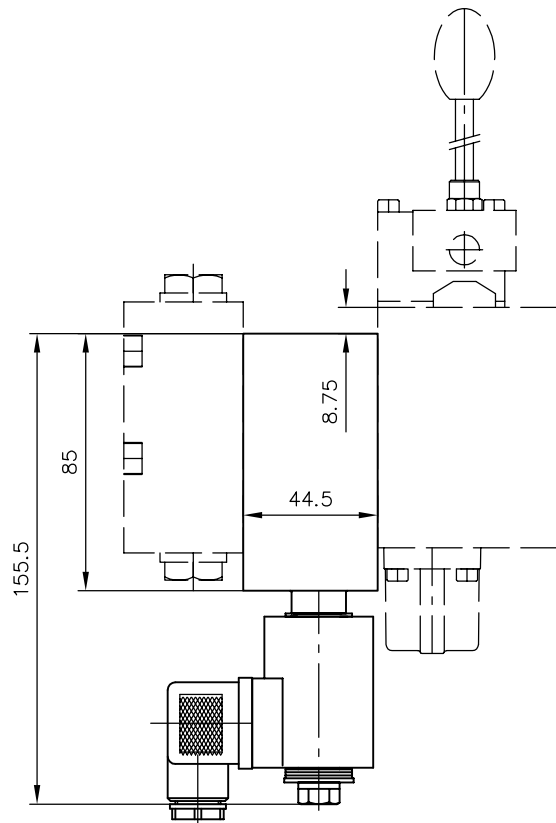

Type /ZXV ¹⁾

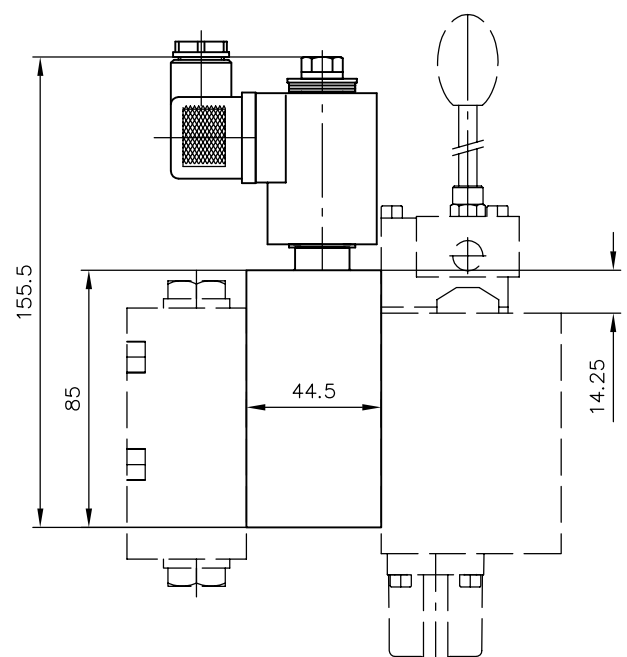

Type /ZDS, /ZDR

Type /Z 2 A_S^RB...

Type /Z 2 B_S^RB... 1)

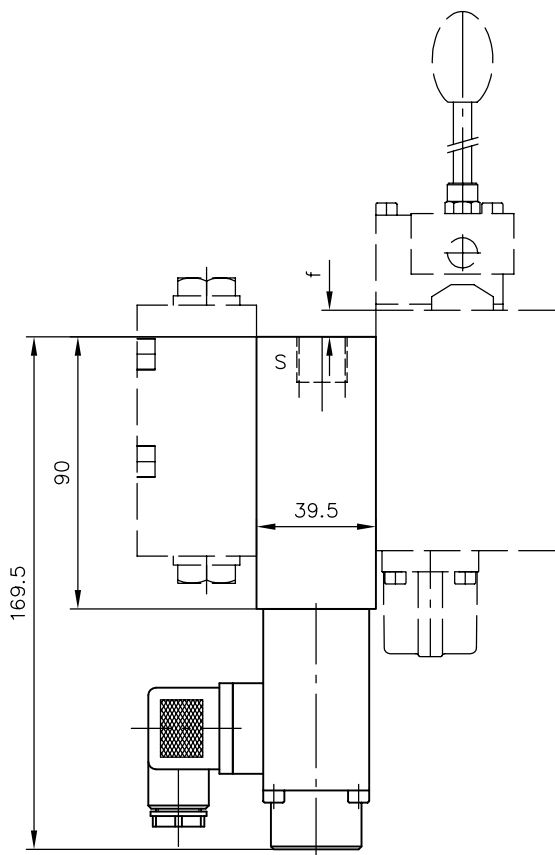

1) **Note:** Not all lever positions are possible.

Type	f
/ZDS, /ZDR	8.75
/Z 2 AR(S)B	3.75
/Z 2 BR(S)B	14.25

Port conf. (ISO 228/1) (BSPP):
S = G 3/8

Type /ZANBN

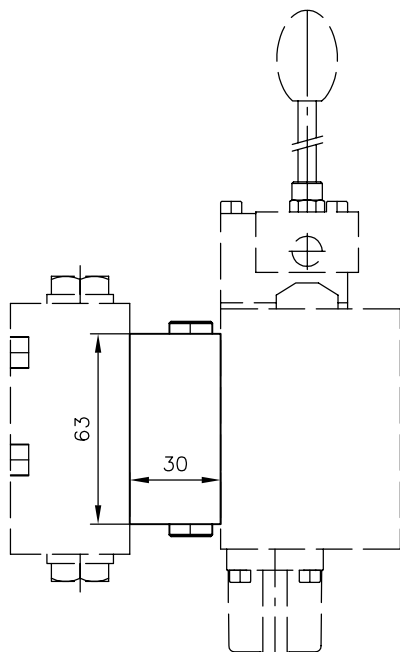

Type /ZDRH 1)

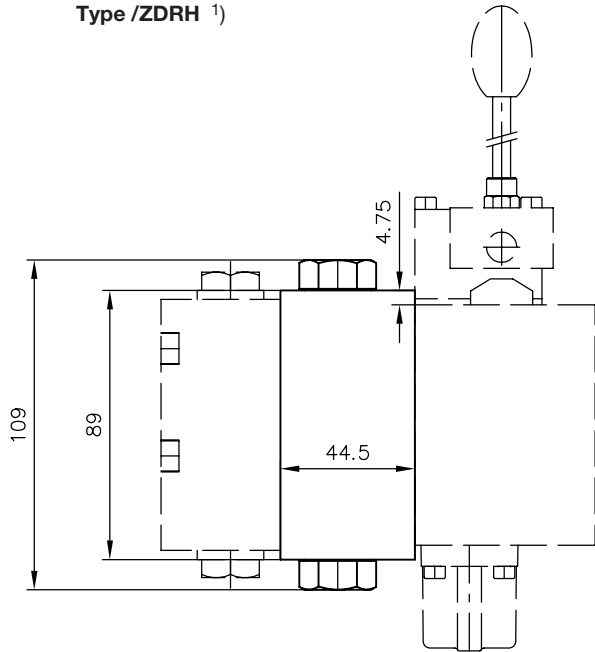

Type /ZAL-...BL-... 1)

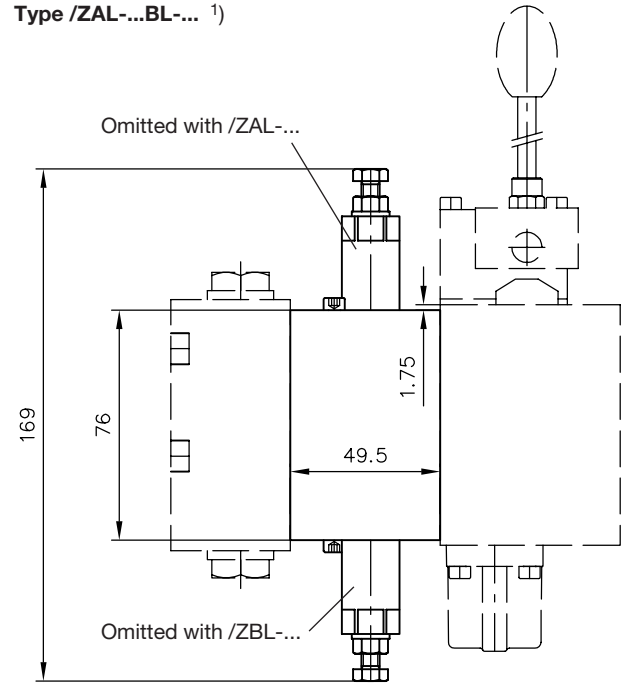

1) **Note:** Not all lever positions are possible.

5.11 In series intermediate plate

Type A 1 RR

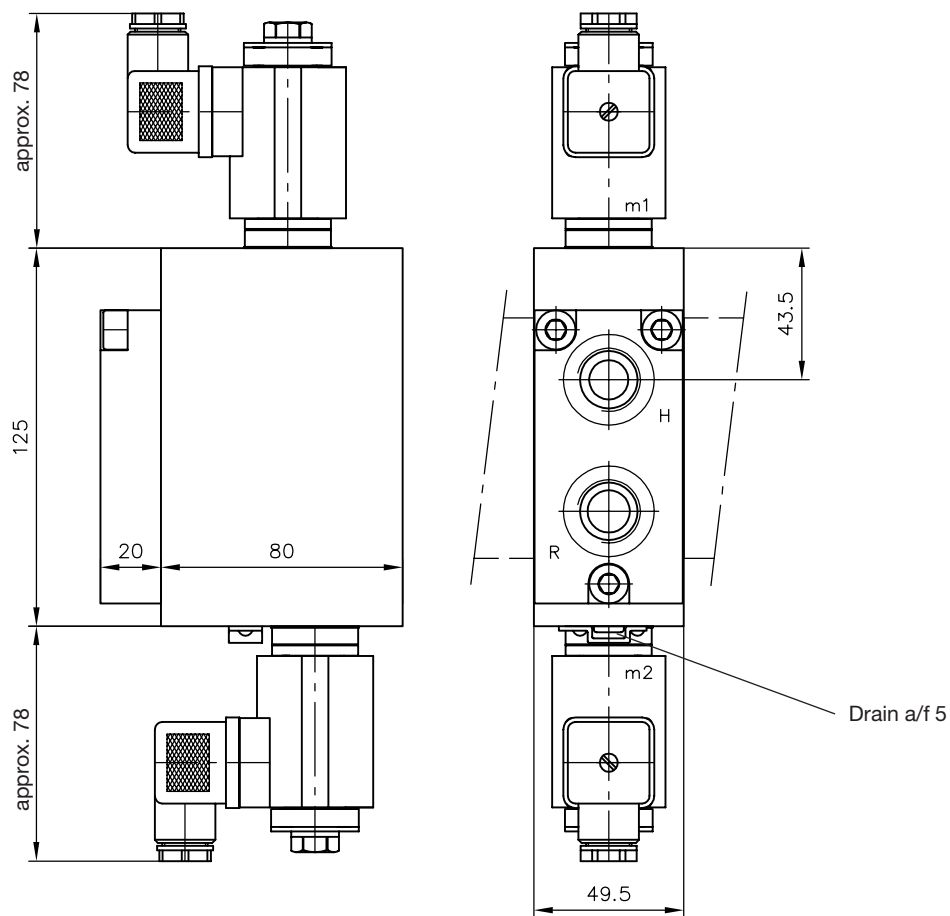

Type Z 22
Z 22/7

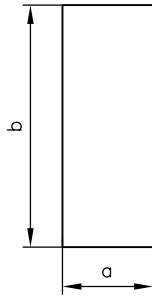

Type ZPL-Z2

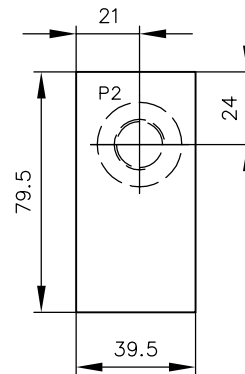

Type	a	b
ZPL 22	39.5	79.5
ZPL 22/7	7	80

Port conf. (ISO 228/1) (BSPP):
P2 = G 1/2

6. Appendix

6.1 Notes for selection and lay-out

a) Connection block

There are, apart from the standard versions acc. to sect. 3.1.1 and 3.1.2 additional damping variations for the LS-signal duct listed in tables 2 or 5. These are required, if strong (load-) oscillations are externally induced on the control circuit. A general rule concerning the use of one or other variation can however not given.

Coding U (or UH)

The pump idle circulation pressure is reduced by means of an additional by-pass valve, if all directional spool valves are in idle position (see also curves in sect. 4.2). The valve opens automatically if the upcoming load pressure (LS pressure) drops below 25% of the (still remaining) pump pressure.

Attention: The load pressure must be at least 20 bar.

Coding G

This version lacks the sequence valve at the damping element which is apparent at the standard version to enable quick depressurization down to the pre-load pressure during idle position of the valve spool. This results in a stronger damping effect than with the standard version, as all fluid from the spring cavity of the 3-way flow controller must pass the thread type throttle. Main application is with consumers prone to low frequent oscillations - drawback is the delayed depressurization down to the pre-load pressure during idle position of the valve spool.

Coding H

If on account of the required consumer velocity at least one spool valve with reference number 5 (raised circulation pressure) is utilized, then, in order to maintain the necessary pressure difference between 2- and 3-way flow controller, the circulation pressure of the 3-way flow controller must be raised to approx. 14 bar. This means, of course, greater power dissipation.

Coding Z, ZM and V

When using these valves for an emergency stop function, it has to be taken into account that there will be a certain min. residual pressure during pushing load while a valve spool is elevated!

Dampening screw acc. to table 2 and 5	Residual pressure at load induced pressure of	
	250 bar	350 bar
Coding		
S, G, W, B	125	150
B 4	60	70
B 5	75	80
B 6	85	95
B 7	100	120

Viscosity $\leq 60 \text{ mm}^2/\text{s}$

b) Spool valve sections

Coding 1 (example SL 2-A 1 L 6/16...)

On the one hand, there is a higher consumer flow with directional spool valves without an inflow controller (coding 1) in comparison with one having a 2-way flow controller (coding 2, 5), as the flow is then directly dependent on the control pressure of either the connection block's 3-way flow controller (approx. 10 bar) in type PSL, or the metering valve of a variable displacement pump (approx. 14 to 20 bar), in type PSV. On the other hand, the load-independence is lost, if several consumers are actuated simultaneously, because the consumer with the highest load pressure rules the pressure level of the LS-signal given to the 3-way flow controller and so defines the available oil flow in the system. When another valve with lower pressure is now actuated, the flow can only be regulated by throttling, which means if the highest load pressure varies, the spool elevation (= throttling) of the second consumer has to be reset to maintain a constant delivery flow to the consumer.

This consumer flow can be calculated approximately by ($Q_{A, B}$ = expected consumer flow, Q_{nom} = rated consumer flow to valve with inflow controller coding 2, $\Delta p_{controller}$ = pressure difference at the flow controller of the connection block pump).

$$Q_{A, B} \approx Q_{nom} \cdot \sqrt{0.2 \cdot \Delta p_{controller}}$$

Coding 2 (example SL 2-A 2 0 16/25...)

The standard version of the spool valve comes with load compensation. Due to the control pressure of the inflow controller (approx. 6 bar), it regulates a constant flow related only to the spool elevation, making its delivery independent of other consumers or system pressure: $Q \approx \sqrt{\Delta p_{\text{controller}} \cdot A_{\text{valve spool}}}$

Coding 5 (example SL 2-A 5 H 40/40...)

This version has an increased control pressure enabling higher consumer flows (see also above coding 1 and 2). The pressure of the flow controller is 10 bar resulting in a 1.3 higher flow compared to the standard version (coding 2)

Coding 7 (example SL 2-A 7 H 40/40)

Like coding 5. To be used only together with variable displacement with connection block type PSV and variable displacement pump / constant pressure system because of the necessary pressure drop.

Coding 8, 81, 82 (example SL 2-A 8 H 40/40)

To ensure max. flow for all subsequent valve sections, the highest flow rating (/40) must be selected for the B side (continuation of P).

Coding AR 2, AR 5 and AR 7

Beside its control function the flow controller acts also as a check valve. Thus preventing a possible flow reversal in case of insufficient supply from the pump.

c) Flow-pattern variations

Flow pattern symbol J, B, R, O, I, Y and V

Oscillations may occur depending on application during start (e.g. winches) or during normal operation (e.g. crane booms). They can be caused by the natural frequency of the hydraulic motors or external load variations e.g. swinging load. The flow coding (table 15) of the respective spool should correspond to the cylinder ratio as far as possible.

Flow pattern symbol	Description	Application
J, B, R, O	Creation of a back pressure $\Delta p_{A(B)-R}$ of approx. 20 bar at 1/3 spool lift and more.	When combined with over-center valves e.g. for boom controls
I, Y, V	Creation of a back pressure $\Delta p_{A(B)-R}$ of approx. 100 bar for up to 1/3 spool lift.	Hydraulic motors (because of pressure rise due to area ratio 1:1), e.g. with cabin slewing

Flow pattern symbol

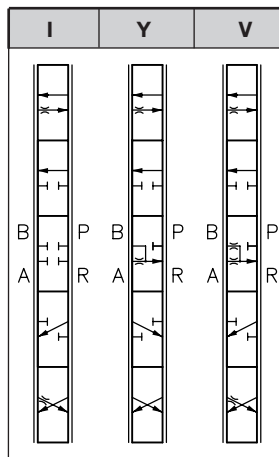

Available versions:

- SL 2 - I 6/6
- I 10/10
- I 16/16
- I 25/25
- I 40/40

- Y 40/40

- V 6/6
- V 10/10
- V 16/16
- V 25/25

Flow pattern symbol W

This 4/2-way directional spool valve is intended for applications where a constant velocity is required e.g. blower or generator drives. The ability of prop. speed control is restricted, but load independency is ensured via the inflow controller (table 13).

Coding acc. to table 13	$Q_{\text{max A, B}}$ (lpm)
2	33
(1)	(47)
5	47
7	52

Flow pattern symbol

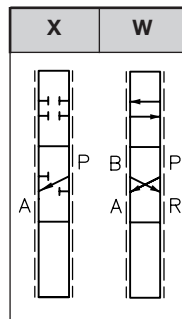

Available versions:

- SL 2 - W 30/30
- SL 2 - X 40

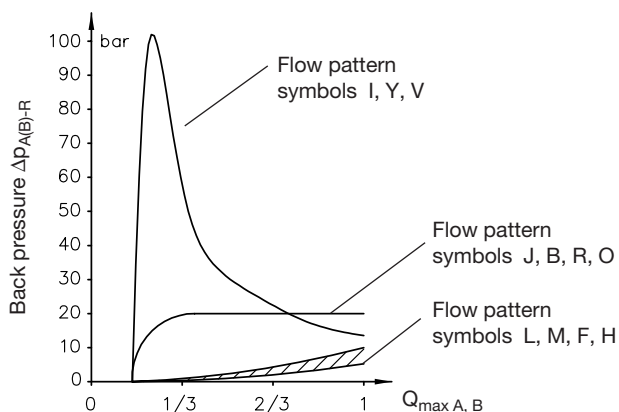

Flow pattern symbol G

3-position 3-way-spool for single acting cylinder

Restrictions:

- No LS-Signal while lowering
- Therefore not usable at open center systems (type PSL) and electric actuation
- The lowering function is just a throttle valve function (load dependent lowering speed). The system needs to be protected by a separate flow control valve (to limit the max. speed e.g. with type SB acc. to D 6920).

Available versions ($Q_A \geq Q_B$):

SL 2 -G 3/3

-G 40/25

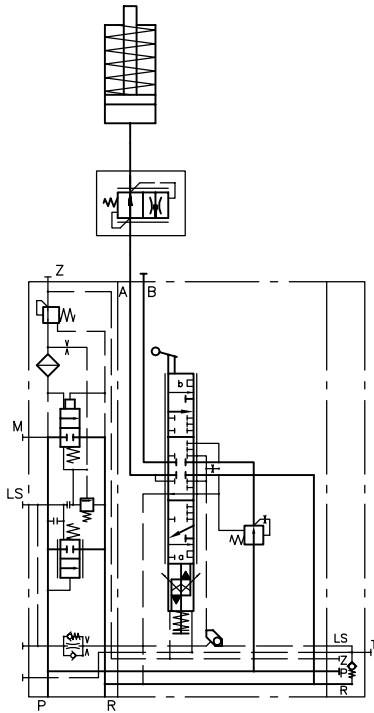
**d) Variations for special operation conditions or -requirements**
Seaworthy version (for maritime climate)

The corrosive sea climate makes necessary a corrosion protection of the moving parts of the manual actuation. Therefore the shaft in the lever housing is made out of stainless steel (standard with all manual actuations). All other parts are corrosion inhibiting gas nitrided or made of stainless steel as standard (Exception: Spring housings of actuations E, EA, A are made of zinc die-cast). When also the spring dome has to be seaworthy, version S of actuation e.g. /EAS has to be ordered (employing the spring dome used with hydraulic actuations).

Combination of electro-hydraulic and hydraulic actuation

A combination of the actuations with hydraulic joy-stick and electrical actuation (e.g. by means of radio control) is possible via a combination of prop. directional spool valves and hydraulic actuation type HA and PMZ-19 or PM12 -19 acc. to D 7625 and use of a pre-selector valve (example circuit acc. to HP 7625 PM12) to the prop. spool valve.

e) Use of variable displacement pumps

Load-sensing controls in alliance with variable displacement pumps, the LS-signal duct for the pump pressure-flow controller (Load-Sensing metering valve) is relieved, to minimize circulation losses during idle position (no consumer flow). This limiting takes place via the proportional spool valves. Without this decompression the pump would have to work during no-lift position with all the remaining flow against the pressure set at the safety valve of the pressure regulator.

As there exist spool valves without this limiting possibility, some brands of pressure-flow controllers have a internal bypass orifice or throttle between LS-signal entrance and decompressed leakage outlet.

In case of the prop. spool valves type PSV this is not necessary and can even cause malfunctions due to lost control oil. The control oil flow is for functional reasons consciously limited (approx. 2 lpm) (slow-motion of the consumer).

Note: Care must therefore be taken, to ensure that a possible bypass orifice in the pressure-flow regulator is plugged!

f) Combination with load-holding valves

It can happen due to exterior variations of load and resonance that the control system starts to oscillate, if three regulation devices, the 3-way flow controller in the pump or the connection block, the 2-way flow controller at the spool valve section plus load holding insert are connected in series. This can be effectively suppressed by systematic use of a bypass orifice and throttle-, check-, pre-load valve combination within the control oil circuit at the load-holding valve type LHDV acc. to D 7770. A similar behavior can be achieved with use of the over-center valves type LHT acc. to D 7918.

g) Combination of more than 10 spool valves

Through the consecutive connection of the LS-signal duct, a total of max. 10 spool valves can be linked. When more than 10 valve sections are necessary, they have to be arranged in a separated valve bank.

h) Mechanical 2-axis joy-stick

Two neighboring valve sections (functions) can be simultaneously actuated via hand lever

Order coding: PSL 31/250 - 2

- A2 L 40/25/K /2 } joint
- A2 H 16/10/K /2 } actuation
- A2 L 40/25/E0A-E 1

(It is possible to combine this mechanical 2-axis joy-stick with electro.-hydraulic actuation)

i) Indications of actuation EHA

The following notes to the connection of the valve bank have to be observed to ensure a flawless function of the electric and hydraulic actuation.

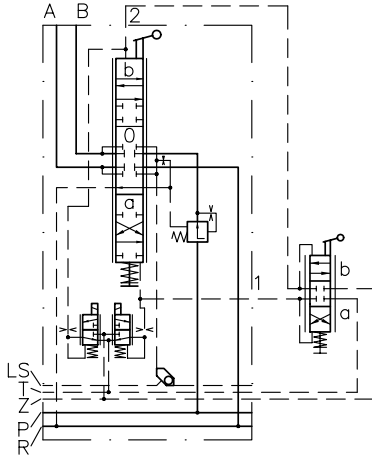
Combination with hydraulic control devices similar (circuitry acc. to example 1)**Example 1****Combination with common hydraulic joysticks or hydraulic control devices type FB and KFB acc. to D 6600 and D 6600-01 (circuitry acc. to example 2)**

The pressure reducing valves integrated in the joy-sticks open the consumer line to the tank during idle position. The control oil flow would escape via this bypass when a valve is simultaneously solenoid actuated. Therefore it is a must to provide check valves for the control lines at this kind of circuitry. The same applies to hydraulic actuations. The used throttles however limit the bypass leakage. The control oil supply must be dimensioned so that this leakage can be compensated (> 0.7 lpm per actuated valve section plus the internal leakage of the hydraulic joy-stick).

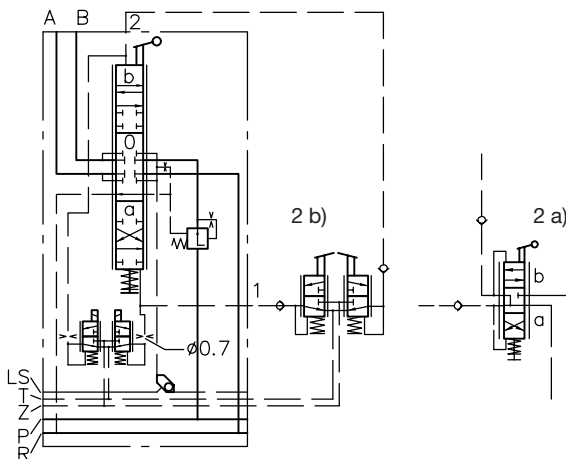
Example 2**j) Optional components****For electro-hydraulic actuations**

1. Plugs MSD 3-309 SVS 296107 Standard, belongs to the scope of delivery
Plug with LED's for functional cut-off acc. to sect. 3.2 table 17 (for more details, see D 7163)
2. Electric amplifier EV 22 K2-12(24) acc. to D 7817/1 One board can control two directional valves.
3. Electric amplifier EV 1 M2 or acc. to D 7831/1 EV 1 D acc. to D 7831 D
A remote control potentiometer with direction switches is required additionally (see detailed information in D 7831/1 sect. 5.2).
4. Logic valve control type PLVC acc. to D 7845 ++
5. joy-stick type EJ1, EJ2 and EJ3 acc. to D 7844
6. Radio controls are accepted, if they fulfill the requirements of SK 7814.

(Approved brands:

Co. HBC-ELEKTRONIK in D-74564 Crailsheim,
Co. HETRONIK Steuer-Systeme in D-84085 Langquaid,
Co. NBB-Nachrichtentechnik in D-75248 Ölbronn-Dürren,
Co. SCANRECO Industrieelektronik AB, Box 19144,
S-5227 Södertälje)

Load-holding valves

Load-holding valves type LHT acc. to D 7918 or type LHDV acc. to D 7770 and note sect. 6.1 f, type LHK acc. to D 7100 only with „very stiff“ systems and directional spool valves without inflow controller (coding 1 acc. to table 15, sect. 3.2.1)

Other valves

Proportional spool valve type PSL(V) size 3 acc. to D 7700-3 (can be combined via intermediate plate ZPL 32 with size 3)
Proportional spool valve type PSL(V) size 5 acc. to D 7700-5 (can be combined via intermediate plate ZPL 52 with size 5)
Proportional spool valve type PSL(V)F size 3 and 5 acc. to D 7700-F (manifold mounting spool valves)
Proportional pressure reducing valve type PMZ acc. to D 7625
Hydraulic joy-stick type KFB01 acc. to D 6600-01

6.2 Circuit examples

The diagrams show a typical valve bank for cranes with hydraulic control.

Example 1:

PSL 31/D 250 - 2 - A 2 L 40/40 A200 B200 /A /2
- A 2 L 25/63 A100 FP 1 /EA/2
- A 2 H 63/25 A80 B80 FP 3 /A /2
- A 1 O 25/40 /A /2 - E 1 - G 24

Control by PSL; supply of pressurized oil by constant delivery pump

to the consumer 1
e.g. swiveling

to the consumer 2
e.g. lifting

to the consumer 3
e.g. folding

to the consumer 4
e.g. supporting

Connection block
PSL 31/D 250-2-

Add-on spool valves
A 2 L 40/40 A200 B200/A/2

Add-on spool valves
A 2 L 25/63 A100 F 1/EA/2

Add-on spool valves
A 2 H 63/25 A80 B80 F 3/A/2

Add-on spool valves
A 1 O 25/40/A/2

End plate

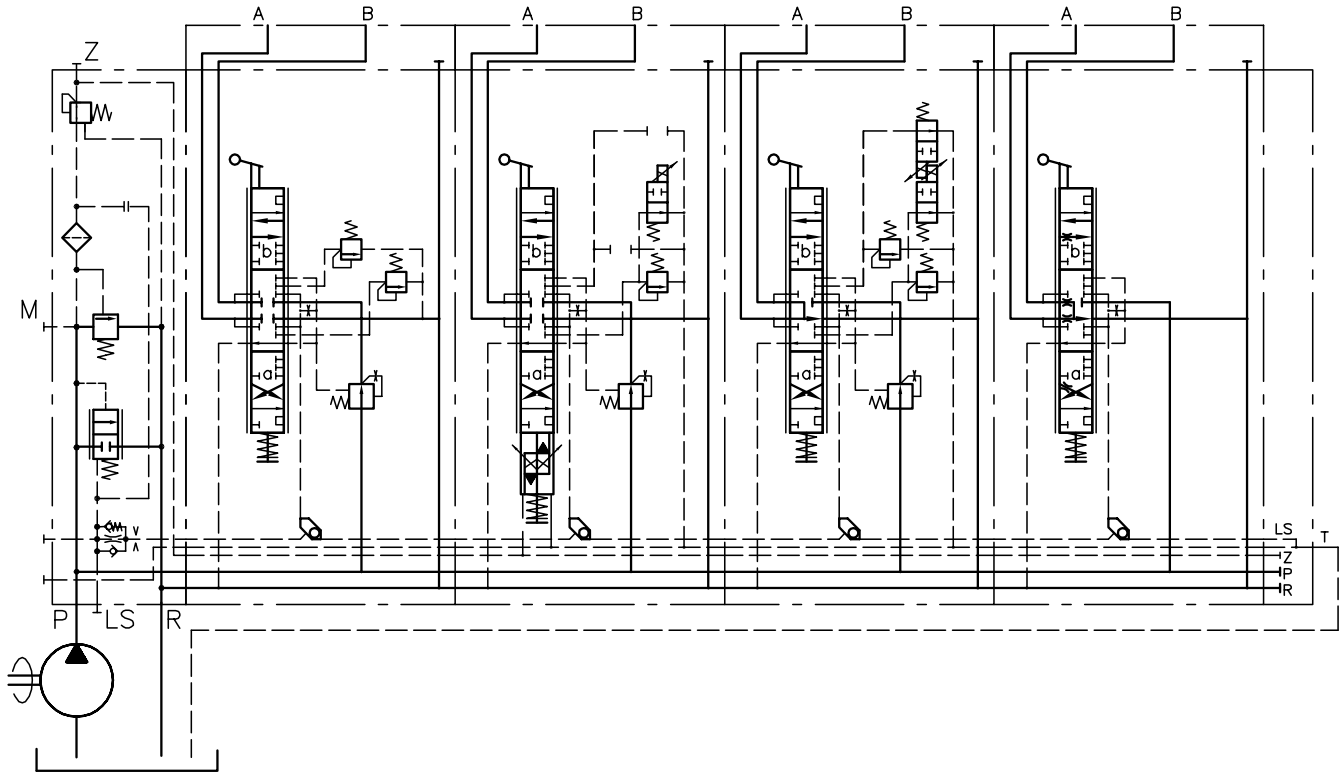

Example 2:

Control by PSV; Pressurized oil supply by variable displacement pump. Only difference to example 1 is the connection block with similar version and arrangement of the add-on valves.

PSV 31/D 250 - 2

- A 2 L 40/40 A200 B200 /A /2
- A 2 L 25/63 A100 FP 1 /EA/2
- A 2 H 63/25 A80 B80 FP 3 /A/2
- A 1 O 25/40 /A /2-E 1-G 24

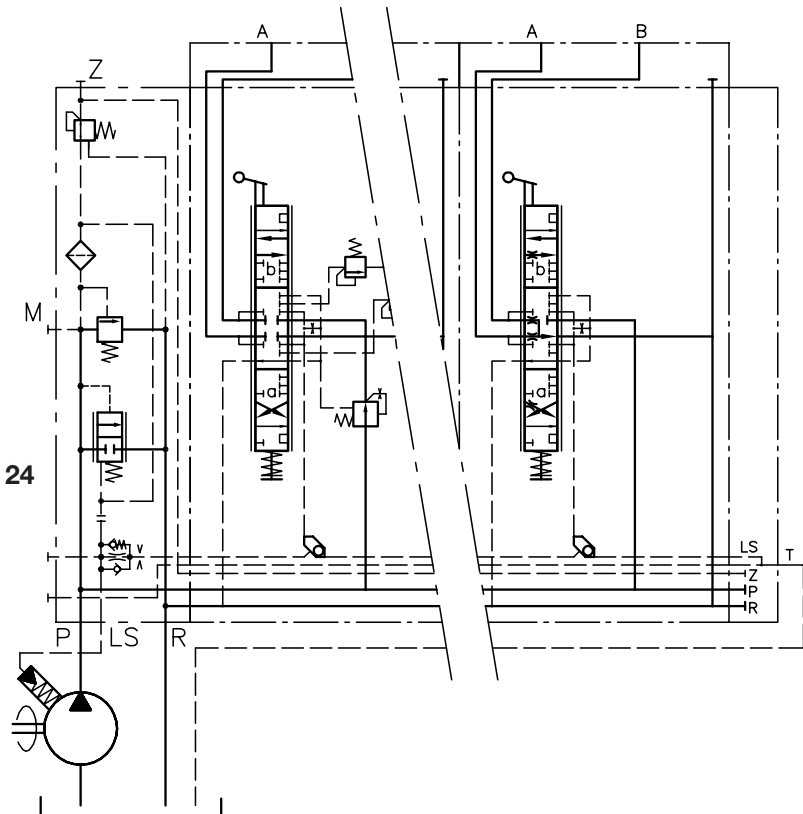

6.3 Notes regarding assembly, installation and conversion

All installation, set-up, maintenance and repairs must be performed by authorized and trained staff.

The use of this product beyond the specified performance limits, use of non specified fluids and/or use of not genuine spares will cause the expiration of the guarantee.

6.3.1 Mounting

The mounting of the valve bank must be performed in such a way that no stress is induced. Three screws and elastic washers between valve assembly and frame are recommended for fastening.

6.3.2 Piping

All fittings used must utilize deformable seal materials. Do not exceed the specified torque!

6.3.3 Notes for converting the connection block

The connection block type PSL 3../D...-2 or PSL UNF 2../D...-2 can be converted any time into a connection block for variable displacement pump systems (correct type then PSV 3 S../D...-2 or PSV UNF 3 S../D...-2). This requires replacing the parts listed below.

Attention: The screws, grub screw, or the orifice are secured with liquid screw lock, which must be applied again when replacing these parts. It is necessary to replace the tapped plug by the damping screw S ⑩ (7778 301), while converting a type PSV to type PSL (does not apply to type PSV 3 S../...-2 or PSV UNF 3 S../...-2, as these are already equipped with it).

Type PSL.../D-2

Type PSV.../D...-2

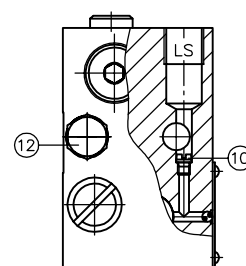
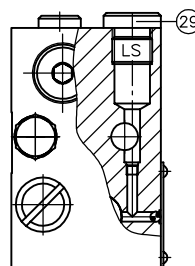

View

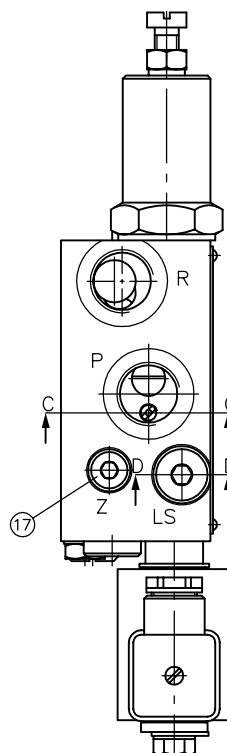
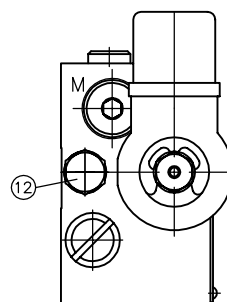

Flow pattern symbols

Type PSL .../D...-2

Type PSV...S/D...-2

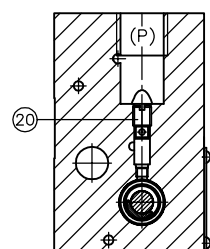
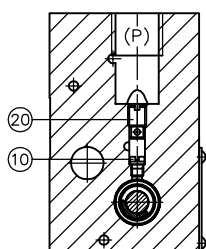
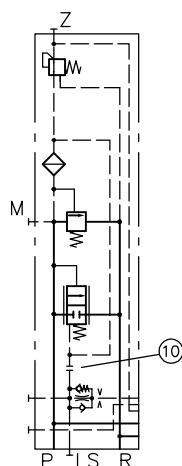
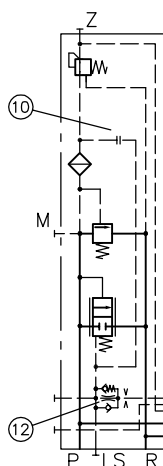

- ⑩ Screw 7997 019
- ⑫ Dampening screw 7778 301
- ⑰ Tapped plug G 1/8 A NBR
- ⑳ Tapped edge filter 7700 794
- ㉑ Tapped plug G 1/4 A NBR

6.3.4 Notes on changing the spool

The valve spools are not mated to one spool housing. Therefore valve spools can be changed at any time to adapt to changing consumer consumption. The following routine is to be followed particularly:

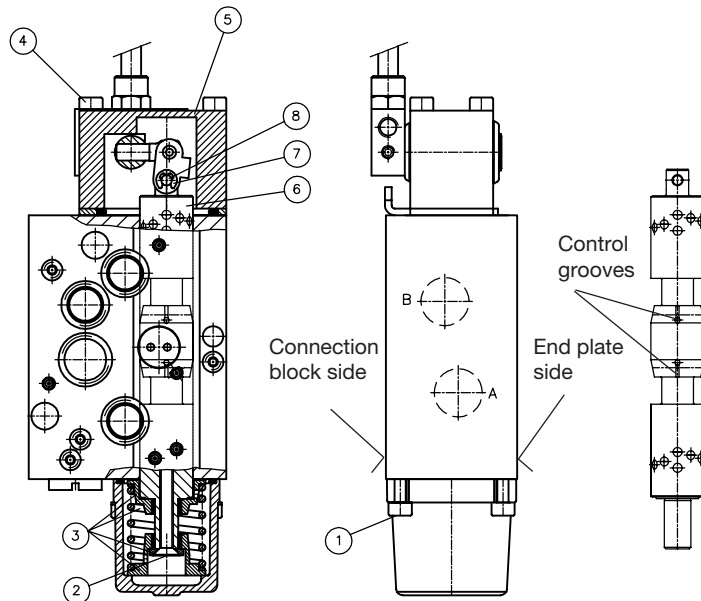

Advice on changing the valve spool

1. Slacken screws ① (ISO 4762-M4x12-8.8-A2-70), remove spring cover
2. Remove screw ② M4x30-8.8
3. Remove spring assembly including spring cap ③
4. Slacken screws ④ (ISO 4762-M4x35-8.8-A2-70)
5. Lift lever housing including spool out of spool housing, drawing ⑤ ⑥
6. Remove lock washer DIN 6799-2.3 and remove bolt ⑦ ⑧
7. Assemble with (new) spool in reverse sequence

Attention: The control grooves of the valve spool should always be installed towards the end plate!
Exception: Valvespools with flow coding 40 do not show control grooves.

6.3.5 Seal kits

Connection block		DS 7700-21
Valve section		DS 7700-22
Intermediate plate	ZPL 32	DS 7700-22
	ZPL 52	DS 7700-52