

IPS High-pressure internal gear pumps for variable speed drives

Product data sheet

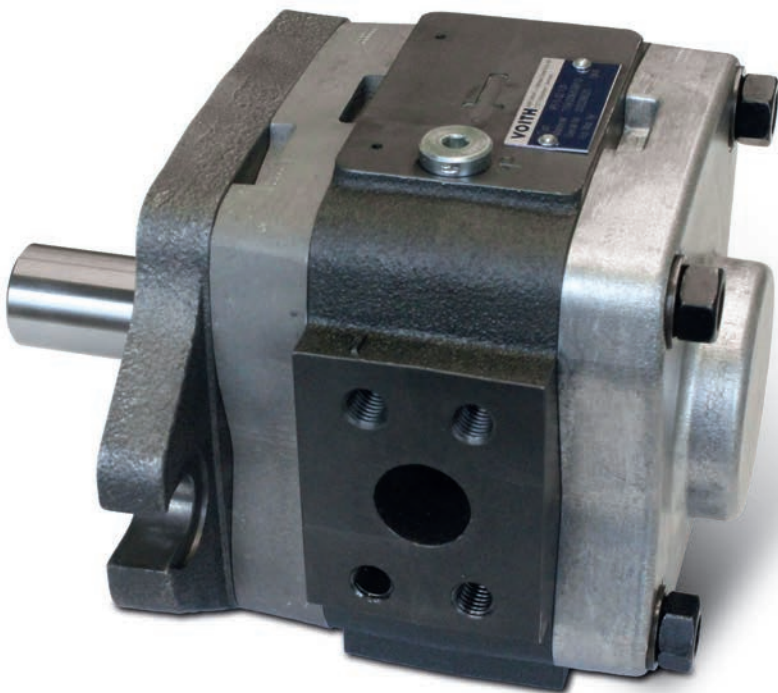

Advantages

- + Very good controllability and pressure hold function
- + Very good pulsation behavior
- + Industry 4.0 compatible
- + Multiple flow capable



Design and function

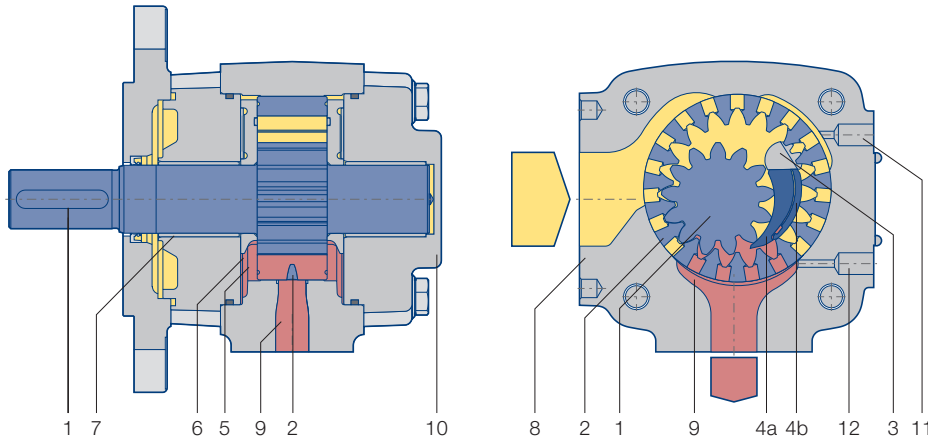

- 1 Pinion shaft
- 2 Internal gear
- 3 Filler pin
- 4a Filler segment carrier
- 4b Filler sealing segment
- 5 Axial disc
- 6 Axial pressure area
- 7 Plain bearings
- 8 Housing
- 9 Hydrostatic bearing
- 10 End cover
- 11 Measuring connection suction side (option)
- 12 Measuring connection pressure side (series)
- Suction chamber
- Pressure chamber

Function

By rotation of the gears inside the pump, the pressure fluid (usually hydraulic oil) is drawn into the cavity between the pinion and internal gear. Optimized cross-sectional areas on suction side as well as on pressure side allow operation over a wide range of speed.

In radial direction, the gear chambers are closed by gear meshing and the filler piece. In the axial direction, the axial plates seal the pressure chamber with the minimal possible gap. This design minimizes volume losses and increases efficiency.

Calculations

Pump flow $Q = V_{g\text{th}} \cdot n \cdot \eta_v \cdot 10^{-3} \text{ [l/min]}$

Power $P = \frac{Q \cdot \Delta p}{600 \cdot \eta_g} \text{ [kW]}$

$V_{g\text{th}}$ pump volume per revolution [cm³]

n Speed [rpm]

η_v Volumetric efficiency

η_g Overall efficiency

Δp Differential pressure [bar]

Technical data

Design	Internal gear pump with radial and axial sealing gap compensation
Type	IPS
Mounting types	SAE hole flange; ISO 3019/1
Line mounting	SAE suction and pressure flange J 518 C Code 61 / 62
Sense of rotation	left or right hand rotation
Mounting position	any
Shaft load	for details please contact J.M. Voith SE & Co. KG
Input pressure	0.8...3 bar absolute pressure (at start up for short time 0.6 bar)
Preload pressure. pressure port (in reversing mode)	for details please contact J.M. Voith SE & Co. KG
Pressure fluid	HLP mineral oils DIN 51524. part 2 or 3
Viscosity range of the pressure fluid	10...300 mm ² s ⁻¹ (cSt). up to $n = 1\,800 \text{ min}^{-1}$ 10...100 mm ² s ⁻¹ (cSt). up to n_{max}
Permissible start viscosity	max. 2 000 mm ² s ⁻¹ (cSt)
Permissible temperature of the pressure fluid	-20 ... +80 °C
Required purity of the pressure fluid according	Class 19/17/14 (ISO 4406). Class 8 (NAS 1638)
Filtration	filtration quotient min. $\beta_{20} \geq 75$. recommended $\beta_{10} \geq 100$ (longer life)
Permissible ambient temperature	-20 ... +60 °C

Static characteristics

Type, size – delivery	Displacement per revolution [cm ³]	Speed min. [min ⁻¹]	Speed max. [min ⁻¹]	Delivery at 1 500 rpm [l/min]	Delivery at n _{max} [l/min]	Con- tinuous pressure [bar]	Peak pressure at 1 500 rpm [bar]	Moment of inertia [kg cm ²]
IPS 3 – 3,5	3.6	400	3 600	5.4	13.0	330	345	0.34
IPS 3 – 5	5.2	400	3 600	7.8	18.7	330	345	0.42
IPS 3 – 6,3	6.4	400	3 600	9.6	23.0	330	345	0.49
IPS 3 – 8	8.2	400	3 600	12.3	29.5	330	345	0.58
IPS 3 – 10	10.2	400	3 600	15.3	36.7	330	345	0.70
IPS 4 – 13	13.3	400	3 600	19.9	47.9	330	345	2.25
IPS 4 – 16	15.8	400	3 600	23.7	56.9	330	345	2.64
IPS 4 – 20	20.7	400	3 600	31.0	74.5	330	345	3.29
IPS 4 – 25	25.4	400	3 600	38.1	91.4	300	330	3.70
IPS 4 – 32	32.6	400	3 600	48.9	117.4	250	280	4.44
IPS 5 – 32	33.1	400	3 000	49.6	99.3	315	345	8.62
IPS 5 – 40	41.0	400	3 000	61.5	123.0	315	345	10.20
IPS 5 – 50	50.3	400	3 000	75.4	150.9	280	315	11.60
IPS 5 – 64	64.9	400	3 000	97.3	194.7	230	250	14.40
IPS 6 – 64	64.1	400	2 600	96.1	166.7	300	330	25.73
IPS 6 – 80	80.7	400	2 600	121.0	209.8	280	315	30.90
IPS 6 – 100	101.3	400	2 600	151.9	263.4	250	300	36.10
IPS 6 – 125	126.2	400	2 600	189.3	328.1	210	250	43.70
IPS 7 – 125	125.8	400	2 500	188.7	314.5	300	330	84.05
IPS 7 – 160	160.8	400	2 500	241.2	402.0	280	315	102.60
IPS 7 – 200	202.7	400	2 500	304.0	503.8	250	300	119.00
IPS 7 – 250	251.7	400	2 500	377.5	629.3	210	250	144.50

The values given apply for

- Pumping of mineral oils with a viscosity of 20...40 mm²s₋₁
- An input pressure of 0.8...3.0 bar absolute

Notes

- Peak pressures apply for 15 % of operating time with a maximum cycle time of 1 minute.
- Please consult us about peak pressures at non-standard speeds.
- Due to production tolerances, the pump volume may be reduced by up to 1.5 %.
- The values for min. and max. speed are dependent on pressure! Please see exact dates on the diagrams from the following pages. At speeds below 400 rpm the pressure must be reduced according to the curve. At high speeds this may be the case as well.

- The pump can be temporarily operating below the specified minimum speed in pressure-hold function. The holding time and the rotational speed required for this purpose is obtained in dependence of the viscosity and of the operating pressure levels. For design details please contact J.M. Voith SE & Co. KG.

Dynamic characteristics

Admissible acceleration [rad/s²]

Size	Delivery	Operation mode A	Operation mode B	Size	Delivery	Operation mode A	Operation mode B	Size	Delivery	Operation mode A	Operation mode B
IPS 3	3,5	4 200	4 200	IPS 5	32	8 911	5 582	IPS 7	125	6 053	3 811
	5	4 200	4 200		40	7 129	4 442		160	6 724	4 250
	6,3	4 200	4 200		50	9 628	6 067		200	7 349	4 658
	8	4 200	4 200		64	7 403	4 643		250	5 894	3 727
	10	4 200	4 200								
IPS 4	13	6 908	4 170	IPS 6	64	7 533	4 739				
	16	6 923	4 199		80	5 937	3 718				
	20	6 140	3 715		100	7 552	4 768				
	25	6 241	3 801		125	6 026	3 792				
	32	8 985	5 606								

Operation mode A

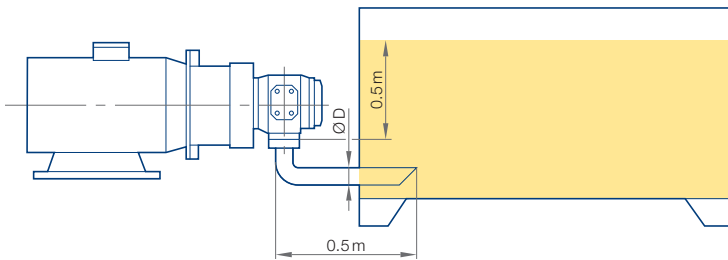

Operation mode B

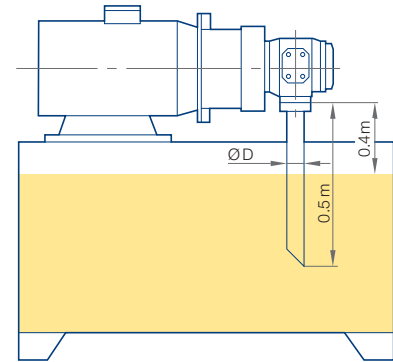

ØD = Diameter suction flange pump housing

The values given apply for

- Dimensioning of the suction port according to operating case A or B
- Pumping of mineral oils with a viscosity of 20 ... 60 mm² s⁻¹ (cSt)

Notes

- Pressure can be built up from standstill when the pump is fully vented. System-related emptying of the pump must be prevented after initial startup.
- The volumetric flow can be freely adjusted via the speed; attention must be paid to the respective pump-specific characteristics.
- Highly dynamic deceleration can be realized, the pressure at the suction side must not exceed the limit value.

- It can be reversed in a highly dynamic manner to reduce pressure peaks or to realize a generator operation. The pressure on the pressure side must not fall below the applied suction pressure.
- The maximum acceleration must be adapted to the installation situation, the viscosity and the suction pressure. Please consult table dynamic characteristics.
- High pressures can be generated at low speeds, attention must be paid to the temperature of the pump. The permissible temperature of the hydraulic fluid must never be exceeded.
- To ensure safe operation, the cycle at the pump should be tested for critical operating points using appropriate sensors and at least 1 kHz sampling rate.

Diagram IPS 3 and IPS 4 – Continuous pressure depending on the speed

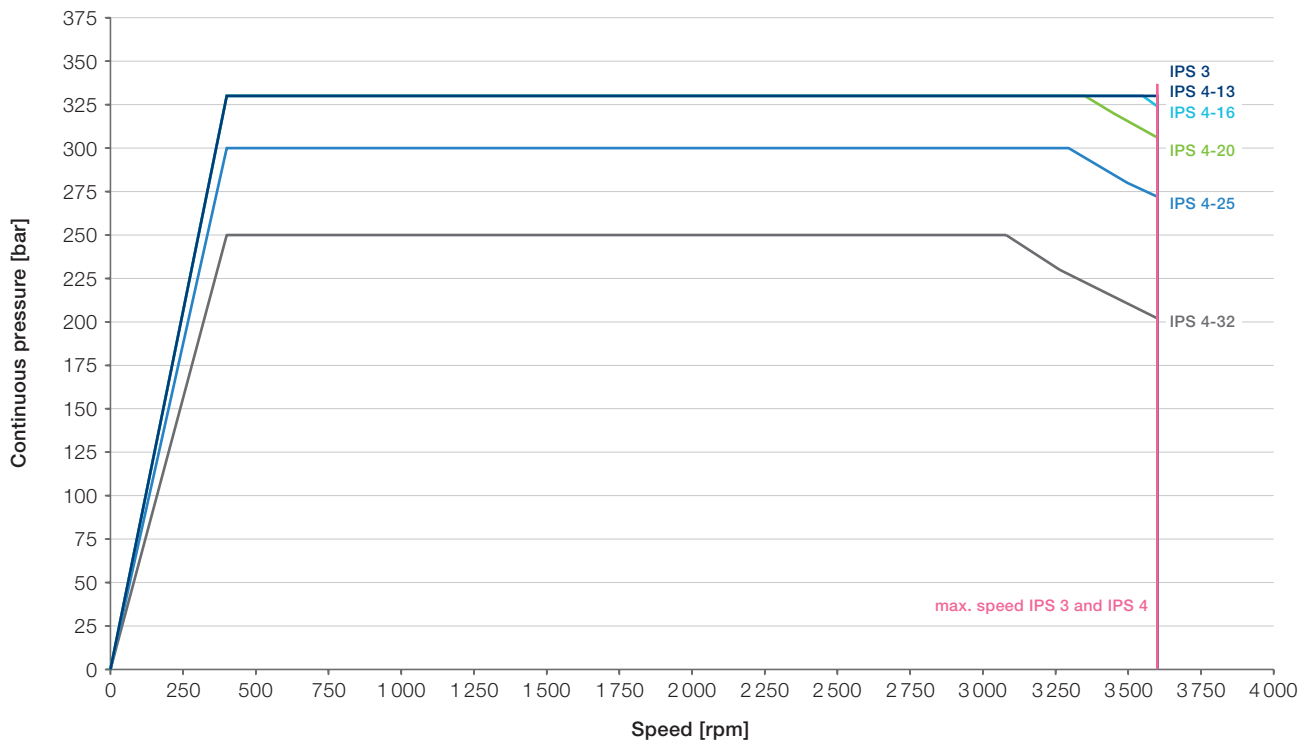

Diagram IPS 5 – Continuous pressure depending on the speed

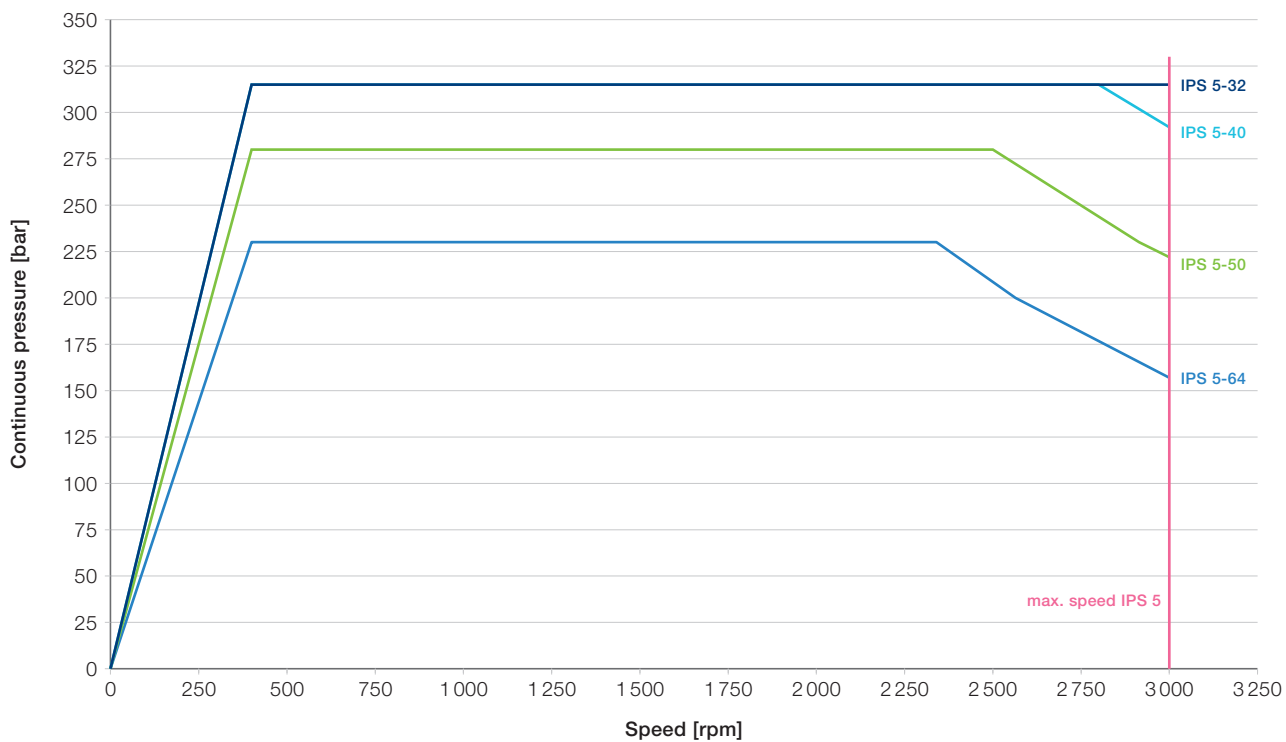

Diagram IPS 6 – Continuous pressure depending on the speed

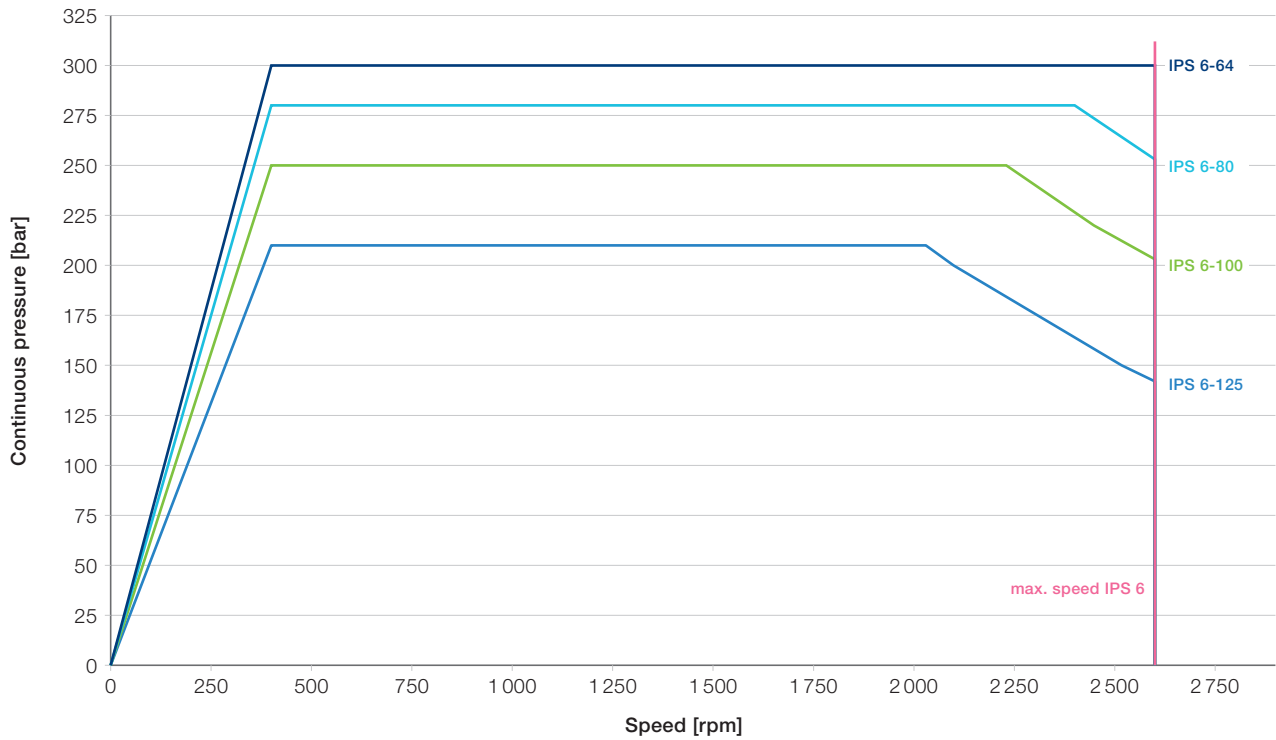
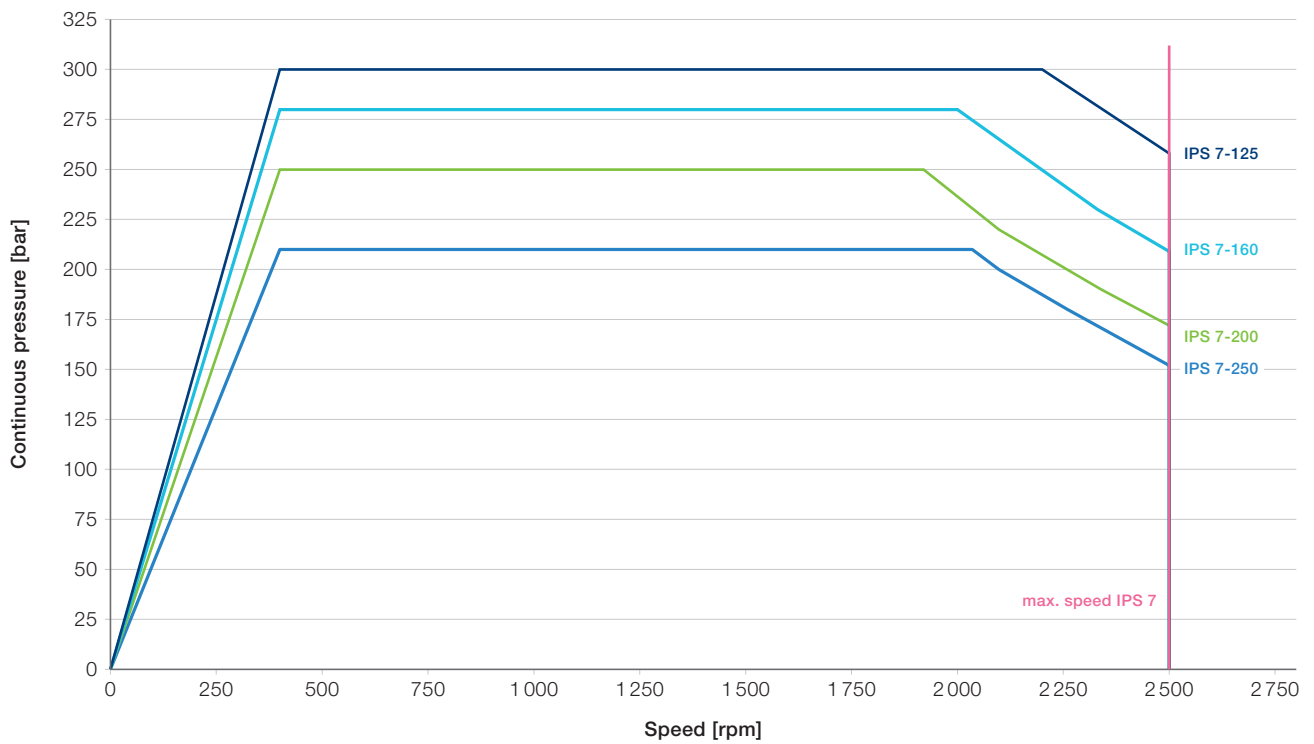
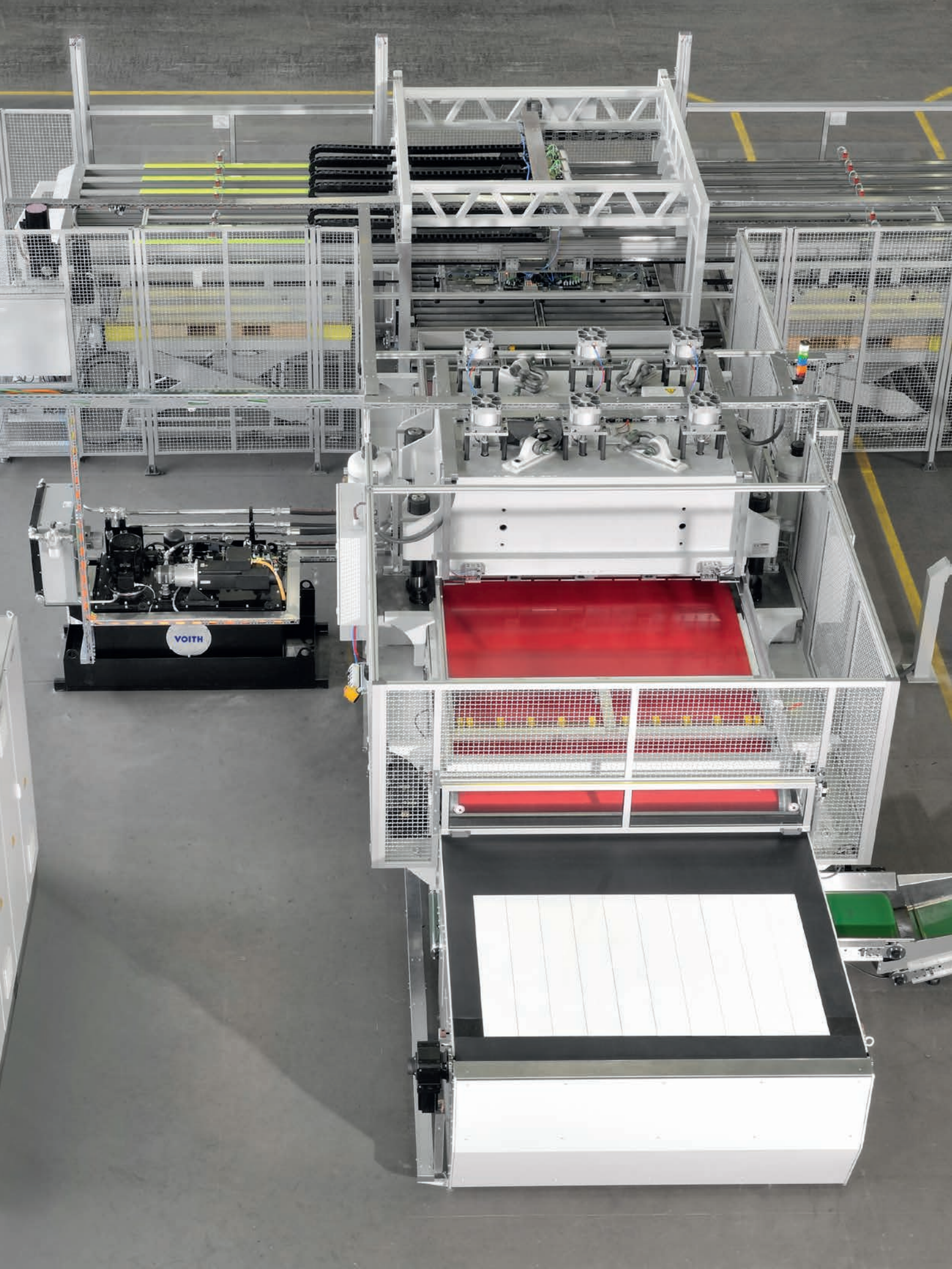

Diagram IPS 7 – Continuous pressure depending on the speed





IPS Size 3 – 3,5, 3 – 5, 3 – 6,3, 3 – 8, 3 – 10: Rotation, dimensions and designs

Rotation clockwise (cw)

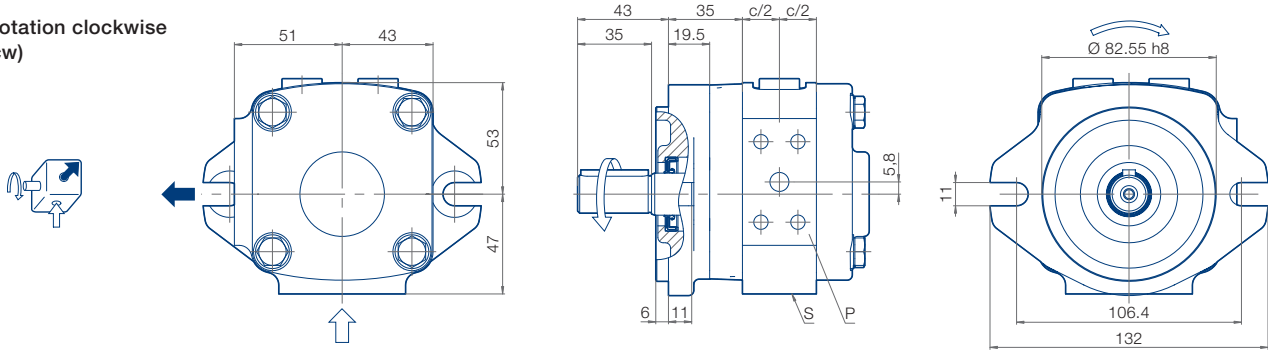

Rotation counter-clockwise (ccw)

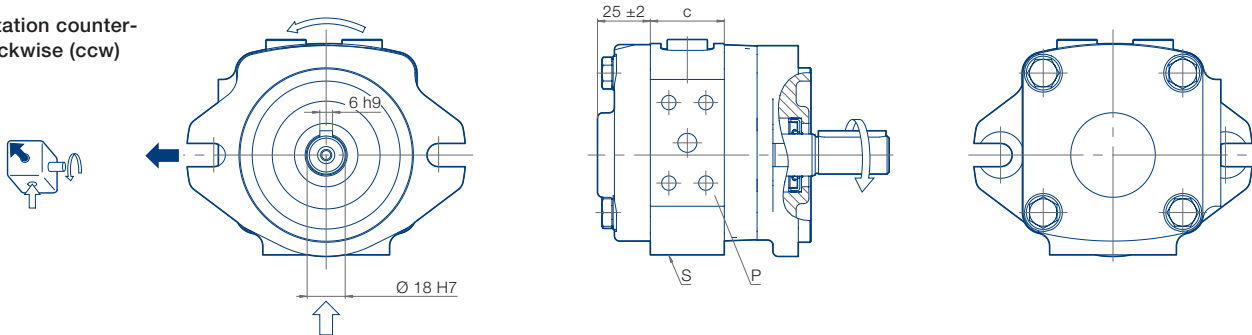

Pressure port (P)

Suction port (S)

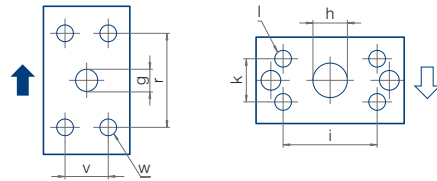

Type/ Delivery	c [mm]	g [mm]	h [mm]	i [mm]	k [mm]	l Thread	r [mm]	v [mm]	w Thread	Weight [kg]	SAE-Flange No. ↑	SAE-Flange No. ↓
IPS 3 – 3,5	35.0	9	14	38.1	17.5	M8x13	38.1	17.5	M8x13	4.2	10	10
IPS 3 – 5	39.0	9	14	38.1	17.5	M8x13	38.1	17.5	M8x13	4.4	10	10
IPS 3 – 6,3	42.0	11	19	47.6	22.3	M10x15	38.1	17.5	M8x13	4.6	10	11
IPS 3 – 8	46.5	13	19	47.6	22.3	M10x15	38.1	17.5	M8x13	4.8	10	11
IPS 3 – 10	51.5	13	21	52.4	26.2	M10x15	38.1	17.5	M8x13	5.0	10	12

Rotation. Suction port

Mounting flange

Shaft end

Standard

Rotation clockwise,
suction connection



SAE 2-hole
flange

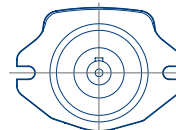
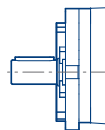

Parallel shaft
with keyway
connection

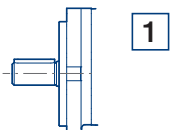

Variants

Rotation counterclockwise,
suction connection



SAE 2-hole
flange

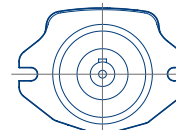
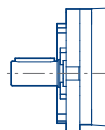

Parallel shaft
with keyway
connection

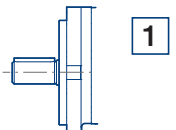

IPS Size 4 – 13, 4 – 16, 4 – 20, 4 – 25: Rotation, dimensions and designs

Rotation clockwise (cw)

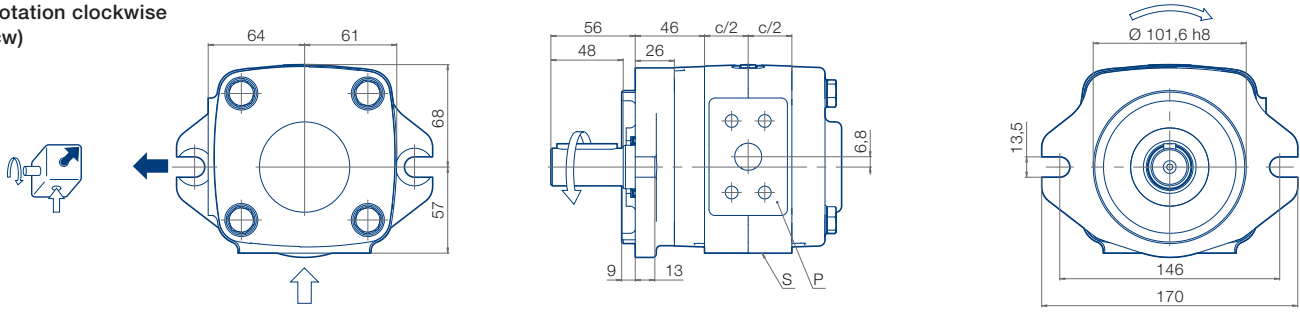

Rotation counter-clockwise (ccw)

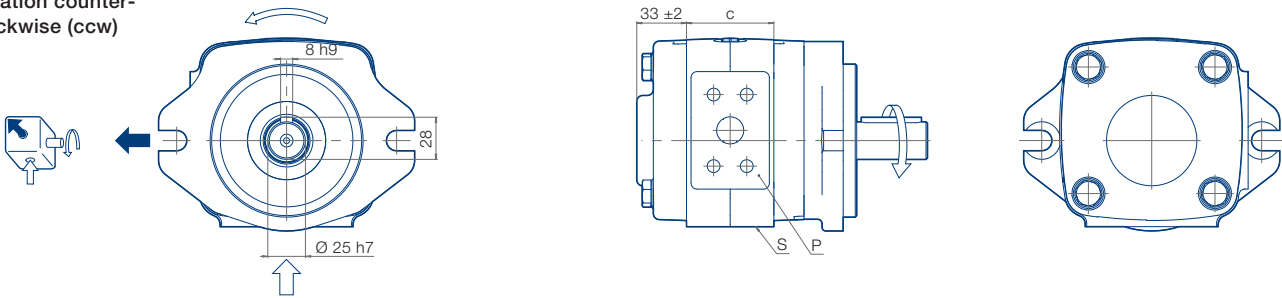

Pressure port (P)

Suction port (S)

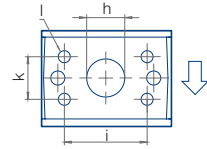
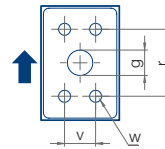

Type/ Delivery	c [mm]	g [mm]	h [mm]	i [mm]	k [mm]	l Thread	r [mm]	v [mm]	w Thread	Weight [kg]	SAE Flange No. ↑	SAE Flange No. ↓
IPS 4 – 13	48.5	13	23	52.4	26.2	M10x15	38.1	17.5	M8x13	9.4	10	12
IPS 4 – 16	52.5	14	25	52.4	26.2	M10x15	38.1	17.5	M8x13	9.7	10	12
IPS 4 – 20	58	18	27	58.7	30.2	M10x15	47.6	22.3	M10x15	10.2	11	13
IPS 4 – 25	64	18	30	58.7	30.2	M10x15	47.6	22.3	M10x15	10.7	11	13

Rotation. Suction port

Mounting flange

Shaft end

Standard

Rotation clockwise,
suction connection



SAE 2-hole
flange

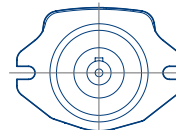
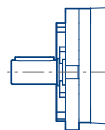

Parallel shaft
with keyway
connection

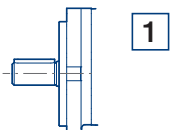

Variants

Rotation counterclockwise,
suction connection

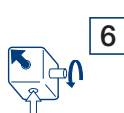

SAE 2-hole
flange

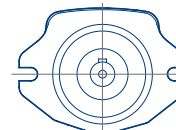
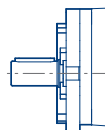

Parallel shaft
with keyway
connection

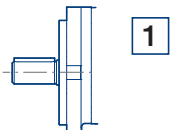

IPS Size 4-32: Rotation, dimensions and designs

Rotation clockwise (cw)

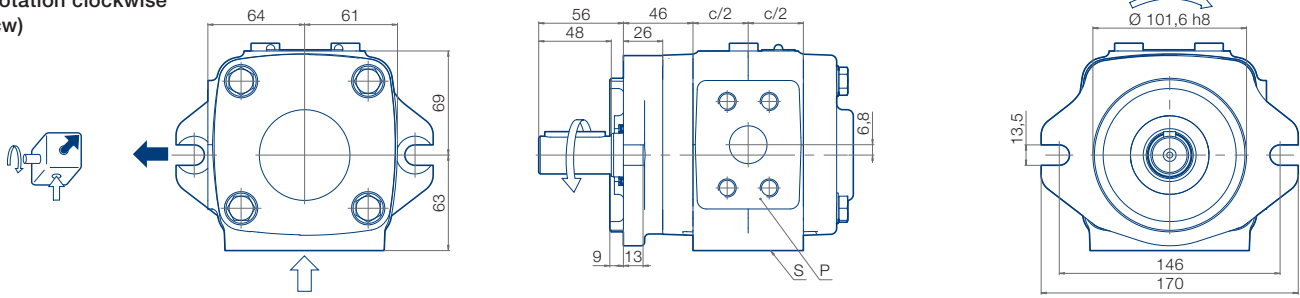

Rotation counter-clockwise (ccw)

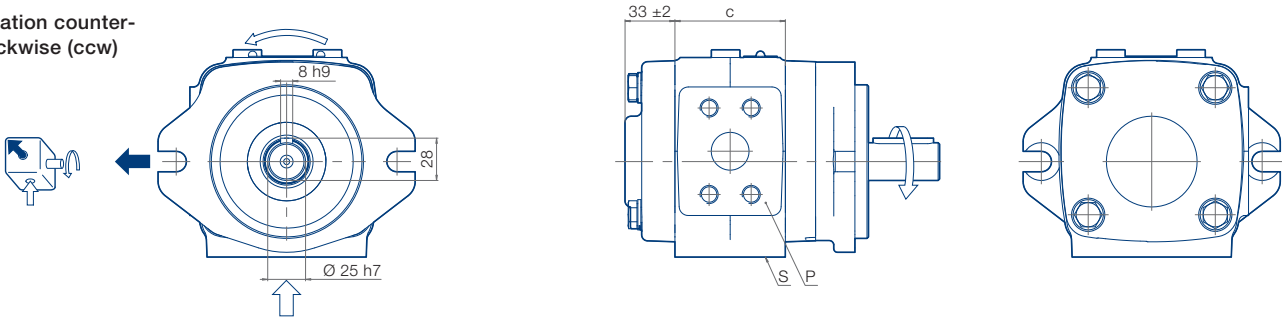

Pressure port (P)

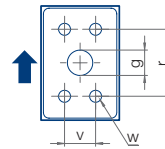

Suction port (S)

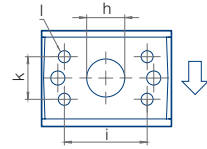

Type/ Delivery	c [mm]	g [mm]	h [mm]	i [mm]	k [mm]	l Thread	r [mm]	v [mm]	w Thread	Weight [kg]	SAE Flange No. ↑	↓
IPS 4 - 32	73	25	40	69.9	35.7	M12x20	57.2	27.8	M12x20	11.7	52	30

Rotation. Suction port

Mounting flange

Shaft end

Standard

Rotation clockwise,
suction connection



SAE 2-hole
flange

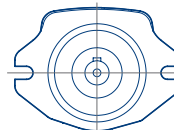
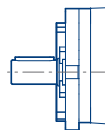

Parallel shaft
with keyway
connection

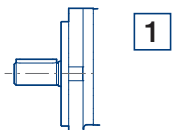

Variants

Rotation counterclockwise,
suction connection

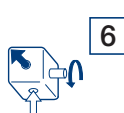

SAE 2-hole
flange

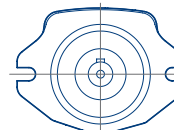
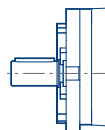

Parallel shaft
with keyway
connection

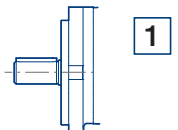

IPS Size 5 – 32, 5 – 40, 5 – 50, 5 – 64: Rotation, dimensions and designs

Rotation clockwise (cw)

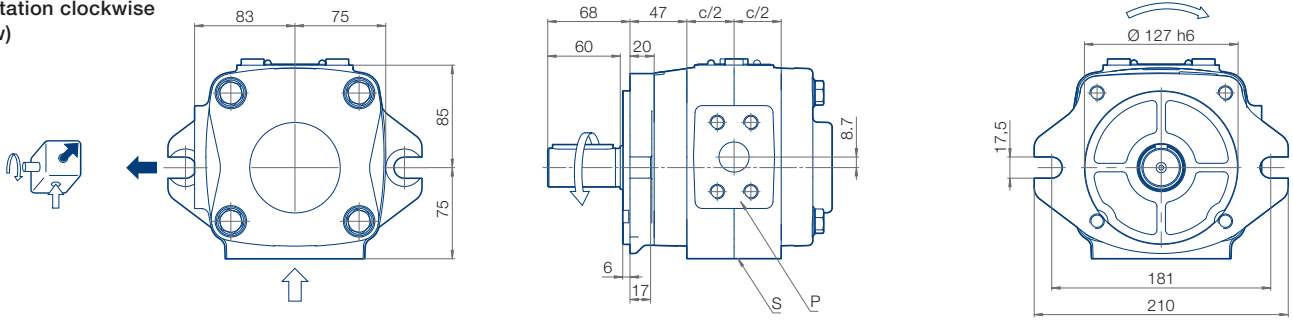

Rotation counter-clockwise (ccw)

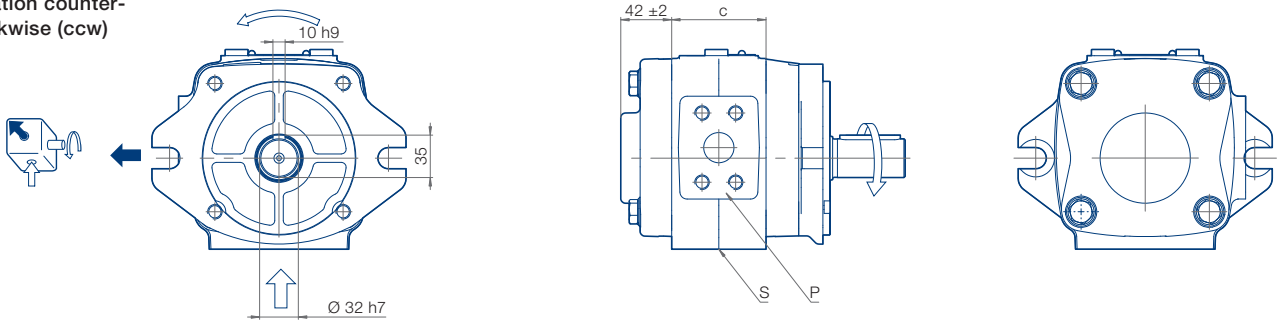

Pressure port (P)

Suction port (S)

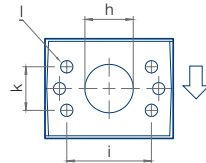
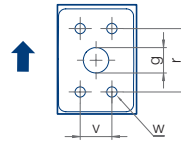

Type/ Delivery	c [mm]	g [mm]	h [mm]	i [mm]	k [mm]	l Thread	r [mm]	v [mm]	w Thread	Weight [kg]	SAE Flange No. ↑	↓
IPS 5 – 32	65	25	40	69.9	35.7	M12x20	57.2	27.8	M12x20	15.6	52	30
IPS 5 – 40	71	25	40	69.9	35.7	M12x20	57.2	27.8	M12x20	16.7	52	30
IPS 5 – 50	78	25	51	77.8	42.9	M12x20	57.2	27.8	M12x20	17.3	52	15
IPS 5 – 64	89	32	51	77.8	42.9	M12x20	66.6	31.8	M14x24	19.1	53a	15

Rotation. Suction port

Mounting flange

Shaft end

Standard

Rotation clockwise, suction connection



SAE 2-hole flange

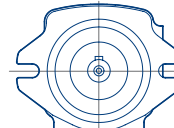
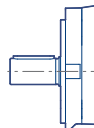

Parallel shaft with keyway connection

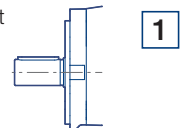

Variants

Rotation counterclockwise, suction connection

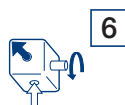

SAE 2-hole flange

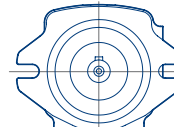
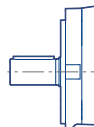

Parallel shaft with keyway connection

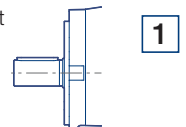

IPS Size 6 – 64, 6 – 80, 6 – 100, 6 – 125: Rotation, dimensions and designs

Rotation clockwise (cw)

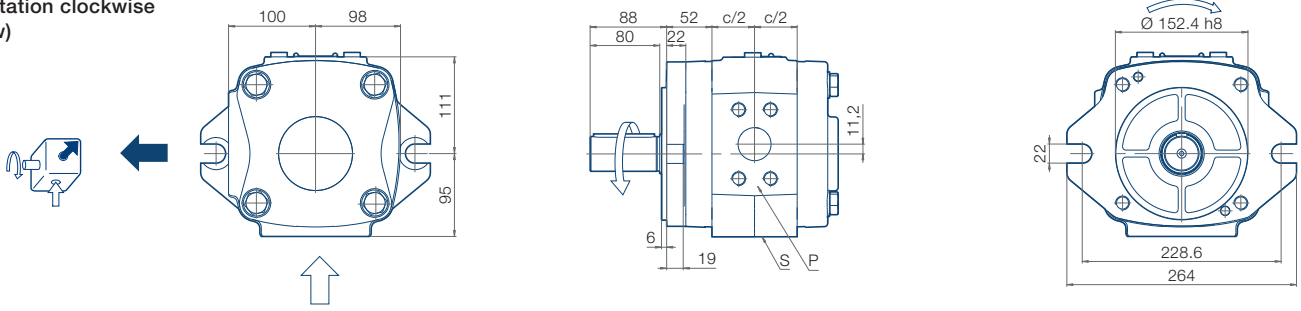

Rotation counter-clockwise (ccw)

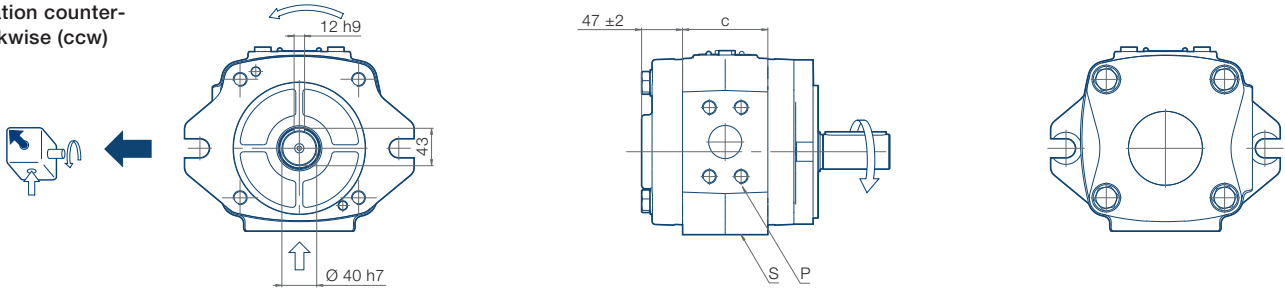

Pressure port (P)

Suction port (S)

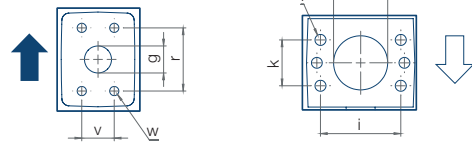

Type/ Delivery	c [mm]	g [mm]	h [mm]	i [mm]	k [mm]	l Thread	r [mm]	v [mm]	w Thread	Weight [kg]	SAE Flange No. ↑	↓
IPS 6 – 64	80	32	51	77.8	42.9	M12x20	66.6	31.8	M14x24	30.0	53a	15
IPS 6 – 80	88	32	51	77.8	42.9	M12x20	66.6	31.8	M14x24	31.7	53a	15
IPS 6 – 100	98	38	64	88.9	50.8	M12x20	79.3	36.5	M16x26	33.0	54	16
IPS 6 – 125	110	38	64	88.9	50.8	M12x20	79.3	36.5	M16x26	36.0	54	16

Rotation. Suction port

Mounting flange

Shaft end

Standard

Rotation clockwise,
suction connection



SAE 2-hole
flange

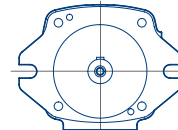
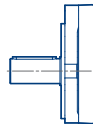

Parallel shaft
with keyway
connection

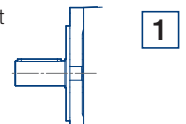

Variants

Rotation counterclockwise,
suction connection

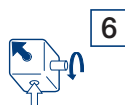

SAE 2-hole
flange

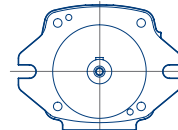
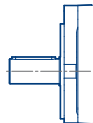

Parallel shaft
with keyway
connection

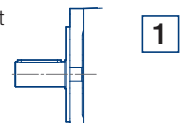

IPS Size 7 – 125, 7 – 160, 7 – 200, 7 – 250: Rotation, dimensions and designs

Rotation clockwise (cw)

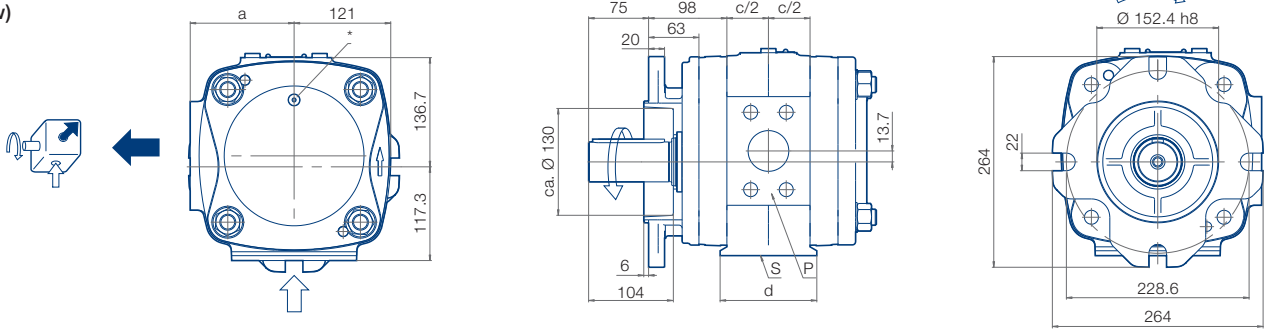

Rotation counter-clockwise (ccw)

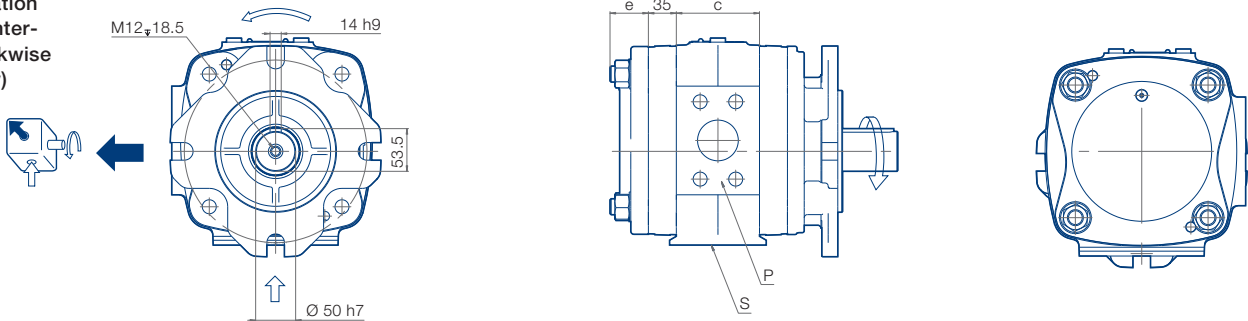

Pressure port (P)

Suction port (S)

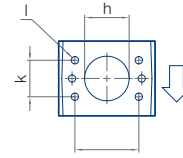
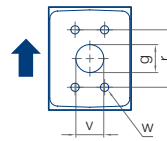

Type/ Delivery	a [mm]	c [mm]	d [mm]	e [mm]	g [mm]	h [mm]	i [mm]	k [mm]	l Thread	r [mm]	v [mm]	w Thread	Weight [kg]	SAE Flange No. ↑	SAE Flange No. ↓
IPS 7 – 125	125	82	91	48	38	64	88.9	50.8	M12x20	79.3	36.5	M16x26	46.5	54	16
IPS 7 – 160	130	92	108	48	51	76	106.4	61.9	M16x26	96.8	44.5	M20x35	50	55	17
IPS 7 – 200	130	104	121	46	51	89	120.7	69.9	M16x26	96.8	44.5	M20x35	54	55	17/2
IPS 7 – 250	130	118	124	42	51	89	120.7	69.9	M16x26	96.8	44.5	M20x35	55	55	17/2

* Ensure the M10x1 plug screw, hexagon socket SW5, is tightened to a torque of 10 Nm during pumping operation. Dependent on the pump position, filling or ventilation is possible here prior to commissioning.

Rotation. Suction port

Mounting flange

Shaft end

Standard

Rotation clockwise, suction connection



SAE 4-hole flange

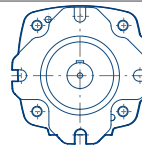
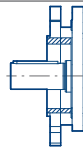

1

Parallel shaft with keyway connection

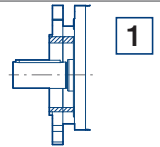

Variants

Rotation counterclockwise, suction connection

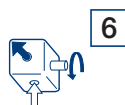

SAE 4-hole flange

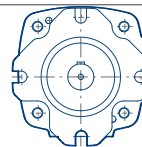
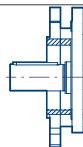

1

Parallel shaft with keyway connection

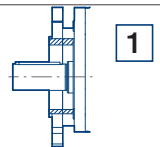

Suction and pressure flange according to SAE...

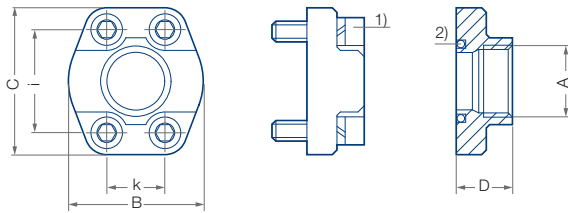

Wrench torque for screws according to ISO 6162

- 1) Screw EN ISO 4762
- 2) Round seal ring (O-Ring) ISO-R 1629 NBR
- 3) Special design. Deviation from SAE J 518 C Code 61

SAE flange no.	A Thread	B [mm]	C [mm]	D [mm]	E ¹⁾ Seal ring	i [mm]	k [mm]	S ²⁾ Thread	Max. pressure [bar]	
SAE J 518 C Code 61	10	G 1/2	46	54	36	18.66 – 3.53	38.1	17.5	M8	345
	11	G 3/4	50	65	36	24.99 – 3.53	47.6	22.3	M10	345
	12	G 1	55	70	38	32.92 – 3.53	52.4	26.2	M10	345
	13	G 1-1/4	68	79	41	37.69 – 3.53	58.7	30.2	M10	276
	14 ³⁾	G 1-1/2	82	98	50	47.22 – 3.53	69.9	35.7	M12	345 ³⁾
	30	G 1-1/2	78	93	45	47.22 – 3.53	69.9	35.7	M12	207
	15	G 2	90	102	45	56.74 – 3.53	77.8	42.9	M12	207
	16	G 2-1/2	105	114	50	69.44 – 3.53	88.9	50.8	M12	172
	17	G 3	124	134	50	85.32 – 3.53	106.4	61.9	M16	138
	17/2	G 3-1/2	136	152	48	98.02 – 3.53	120.7	69.9	M16	35
18	G 4	146	162	48	110.72 – 3.53	130.2	77.8	M16	34	
SAE J 518 C Code 62	50	G 1/2	46	54	36	18.66 – 3.35	40.5	18.2	M8	414
	51	G 3/4	55	71	35	24.99 – 3.53	50.8	23.8	M10	414
	52	G 1	65	81	42	32.92 – 3.53	57.2	27.8	M12	414
	53a	G 1-1/4	78	95	45	37.69 – 3.53	66.6	31.8	M14	414
	54	G 1-1/2	94	112	112	47.22 – 3.53	79.3	36.5	M16	414
	55	G 2	114	134	65	56.75 – 3.53	96.8	44.5	M20	400
	56	G 2-1/2	152	180	80	69.45 – 3.53	123.8	58.8	M24	400

Measuring ports

Size

- 3 – 3,5
- 3 – 5
- 3 – 6,3
- 3 – 8
- 3 – 10

Locking screws: G 1/4
Tightening torque: 30 Nm

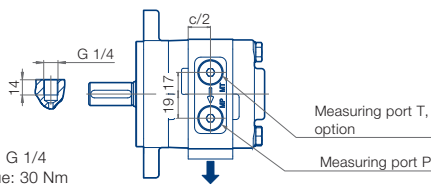

Size

- 4 – 13
- 4 – 16
- 4 – 20
- 4 – 25

Locking screws: G 1/4
Tightening torque: 30 Nm

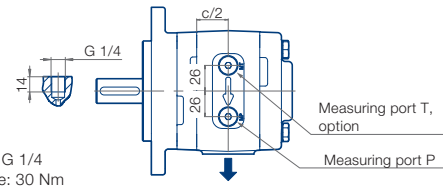

4 – 32

Locking screws: G 1/4
Tightening torque: 30 Nm

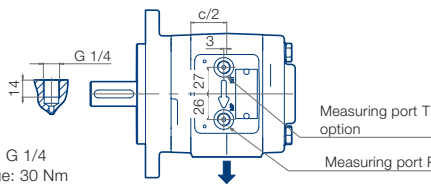

- 5 – 32
- 5 – 40
- 5 – 50
- 5 – 64

Locking screws: G 1/4
Tightening torque: 30 Nm

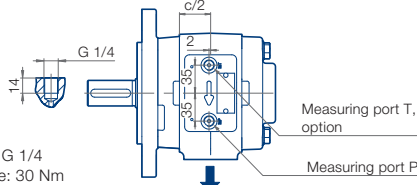

- 6 – 64
- 6 – 80
- 6 – 100
- 6 – 125

Locking screws: G 1/4
Tightening torque: 30 Nm

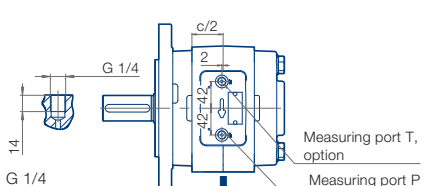

- 7 – 125
- 7 – 160
- 7 – 200
- 7 – 250

Locking screws: G 1/4
Tightening torque: 30 Nm

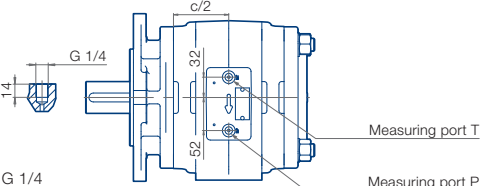

Unused measuring connections must be closed during operation. Plugs are scope of delivery.

Measurement values – Airborne noise level (measuring location 1 m axial)

IPS 3

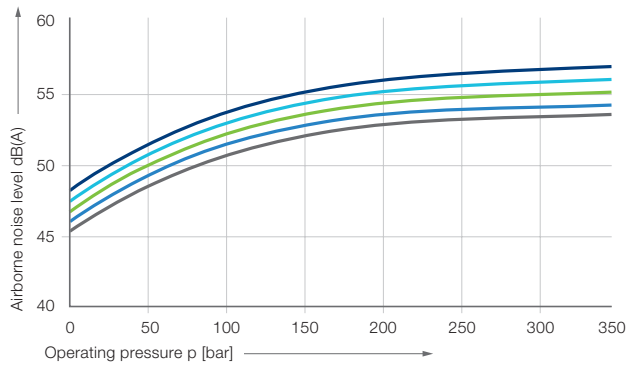

— IPS 3 – 10 — IPS 3 – 8 — IPS 3 – 6.3
— IPS 3 – 5 — IPS 3 – 3.5

IPS 4

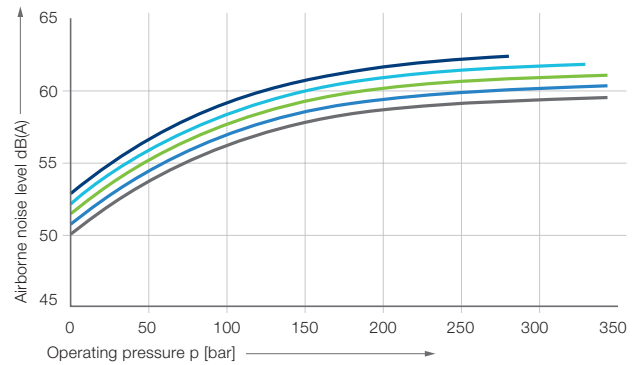

— IPS 4 – 32 — IPS 4 – 25 — IPS 4 – 20
— IPS 4 – 16 — IPS 4 – 13

IPS 5

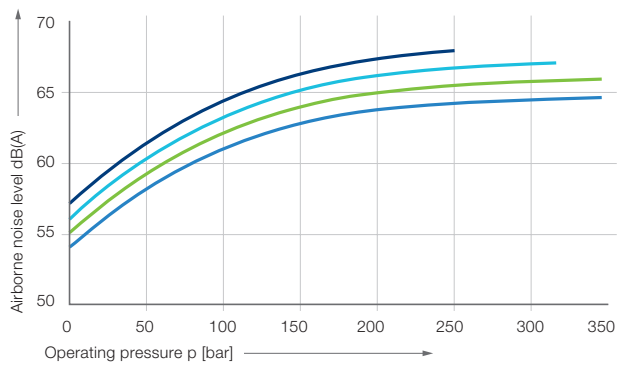

— IPS 5 – 64 — IPS 5 – 50
— IPS 5 – 40 — IPS 5 – 32

IPS 6

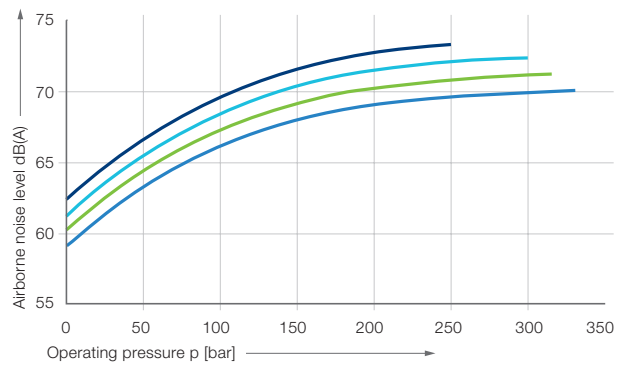

— IPS 6 – 125 — IPS 6 – 100
— IPS 6 – 80 — IPS 6 – 64

IPS 7

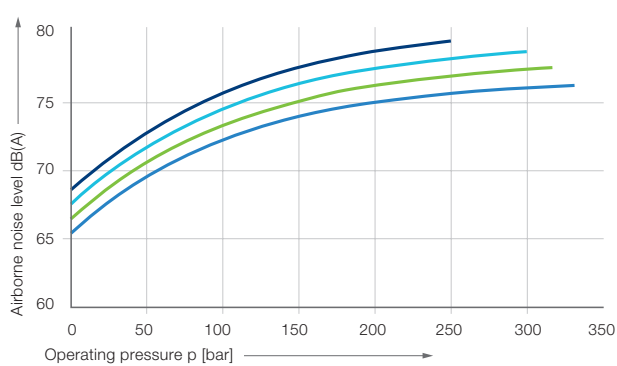

— IPS 7 – 250 — IPS 7 – 200
— IPS 7 – 160 — IPS 7 – 125

Measurement conditions

- Speed: 1 500 rpm
- Viscosity of pressure fluid: 46 mm²s⁻¹
- Operating temperature: 40 °C

Note

Measurement taken in a low-noise room. In a anechoic room the measurements are approx. 5 dB(A) lower.

Measurement values – Efficiency η_v and η_g

IPS 3

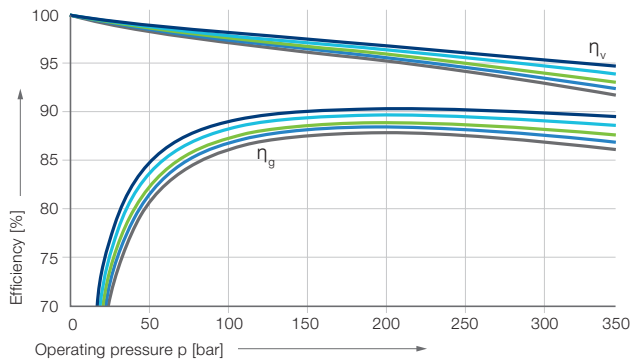

— IPS 3 – 10 — IPS 3 – 8 — IPS 3 – 6.3
— IPS 3 – 5 — IPS 3 – 3.5

IPS 4

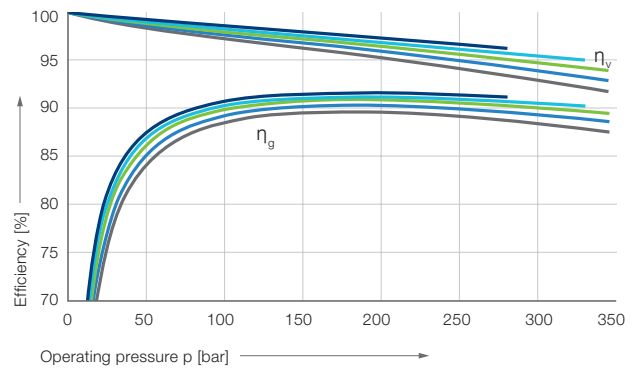

— IPS 4 – 32 — IPS 4 – 25 — IPS 4 – 20
— IPS 4 – 16 — IPS 4 – 13

IPS 5

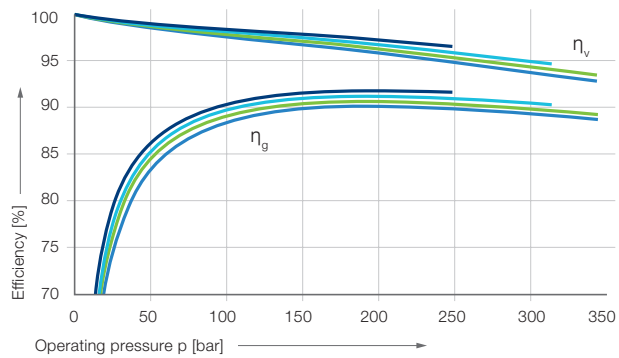

— IPS 5 – 64 — IPS 5 – 50
— IPS 5 – 40 — IPS 5 – 32

IPS 6

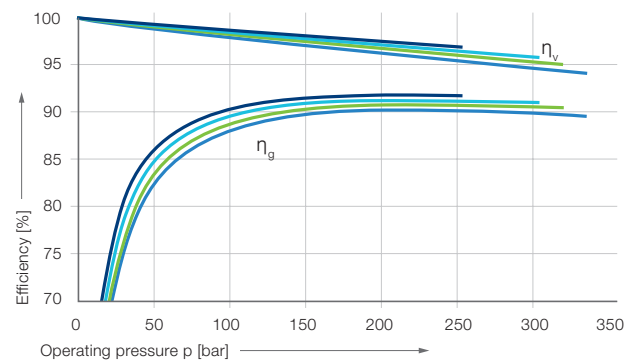

— IPS 6 – 125 — IPS 6 – 100
— IPS 6 – 80 — IPS 6 – 64

IPS 7

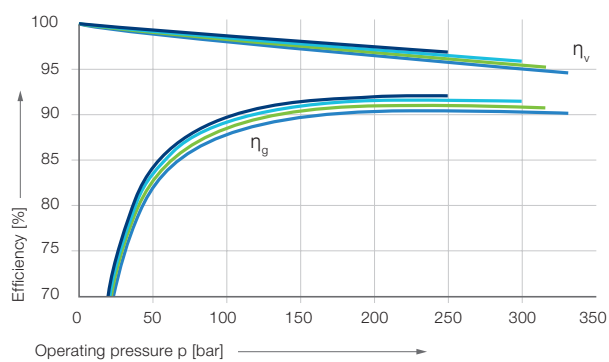

— IPS 7 – 250 — IPS 7 – 200
— IPS 7 – 160 — IPS 7 – 125

Measurement conditions

- Speed: 1 500 rpm
- Viscosity of pressure fluid: 46 mm²s⁻¹
- Operating temperature: 40 °C

Multi-flow pumps, Pump combinations

Pump combinations in order of type and size

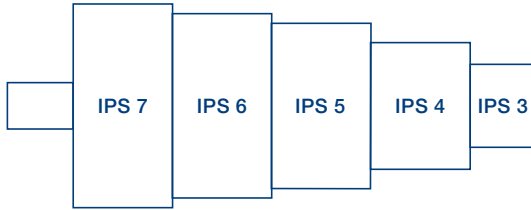













Pump combinations

- IPS pumps of identical or different sizes can be combined in multiflow pumps
- All sizes of the relevant pump volume are available as two- or three-flow pumps; four-flow pumps must be designed by Voith
- The pumps are arranged in decreasing order according to frame size and delivery

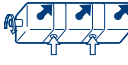
Selection

1. Determine pressure ranges and define the appropriate pump serie(s)
2. Determine pump volume and select the appropriate size
3. Define sequence of the pumps
4. Check the torques
5. Determine rotation and suction
6. Specify mounting

Rotation and suction	Mounting flange	Shaft end
clockwise (cw)   counterclockwise (ccw)		
 2 7 	 	
 1 6 	0 1	1
 2 7 	4	
 1 6 	7	
Special design 4 9 Special design	For designs and dimensions, see catalog of the relevant pump series.	For designs and dimensions, see catalog of the relevant pump series
	0 SAE-2-hole-flange 7 SAE-2-hole-flange (variant) 1 SAE-4-hole-flange	

Allowed input torques

Size	A [Nm]	B [Nm]
3	160	80
4	335	190
5	605	400
6	1 050	780
7	1 960	1 200

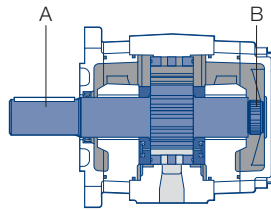

Type Code

IPS 5-32 1 0 1

Shaft end

- 1 Parallel shaft with keyway

Mounting flange

- 0 SAE 2-hole
- 1 SAE 4-hole
- 7 SAE 2-hole, variant

Rotation, suction port

- 1 Clockwise rotation, radial suction port radial
- 6 Counterclockwise rotation, radial suction port radial
- 4 Clockwise rotation, special design
- 9 Counterclockwise rotation, special design

Delivery

Size	Delivery				
3	3.5	5	6.3	8	10
4	13	16	20	25	32
5	32	40	50	64	
6	64	80	100	125	
7	125	160	200	250	

Size

Type

This is a translated document
Original language: German.
Legally binding language version of the document: German.
3159-000108-DSH-DEX-00

Voith Group
St. Poeltener Str. 43
89522 Heidenheim
Germany

www.voith.com/hydraulics

Contact:
Phone +49 7152 992 3
sales-rut@voith.com



VOITH